



Dinosaur Electronics

PO Box 1263, 1160 SE 27th St.

Lincoln City, OR 97367

Ph. (541) 994-4344 Fax: (541) 994-2796

2-way Installation

(2-way refrigerators have one mode button only, marked Auto, and no DC lights)

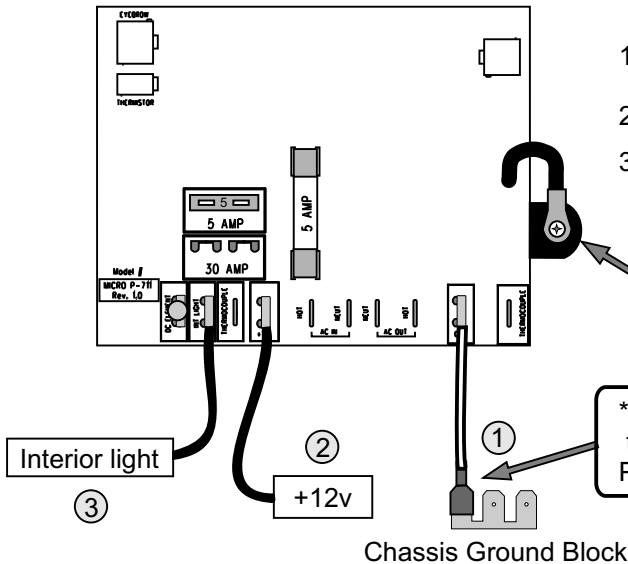

1. MAKE SURE THE AC POWER CORD IS UNPLUGGED FIRST, Hook up the Ground wire first (see below).*
2. Hook up the +12v wire.
3. Hook up the interior light.

The MICRO P-711 has a additional chassis ground wire attached, which is secured by one of the mounting screws. (you still need to connect the wire from J10 to GND, as shown below)

*The GND terminal on the MICRO P-711 board MUST be connected to the ground block of the refrigerator. IF THIS WIRE IS NOT PRESENT, YOU MUST MAKE ONE.

Chassis Ground Block

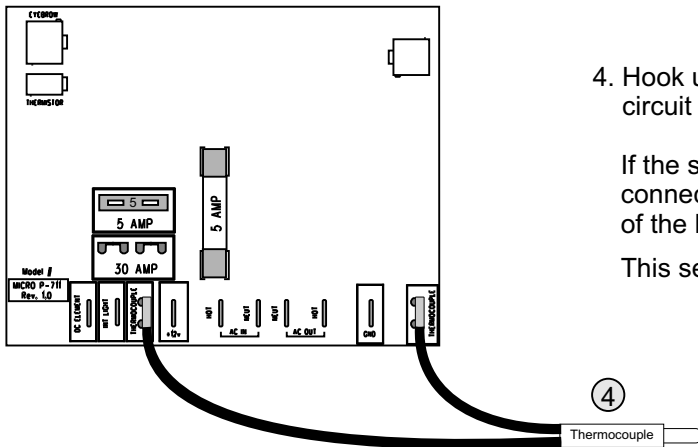

4. Hook up the thermocouple. Note that both leads connect to the circuit board. HOOK IT UP JUST LIKE THE DRAWING INDICATES.

If the short wire is connected to the chassis ground block, disconnect it and put it on the terminal at the bottom-right corner of the board.

This set-up prevents check light problems caused by ground bounce.

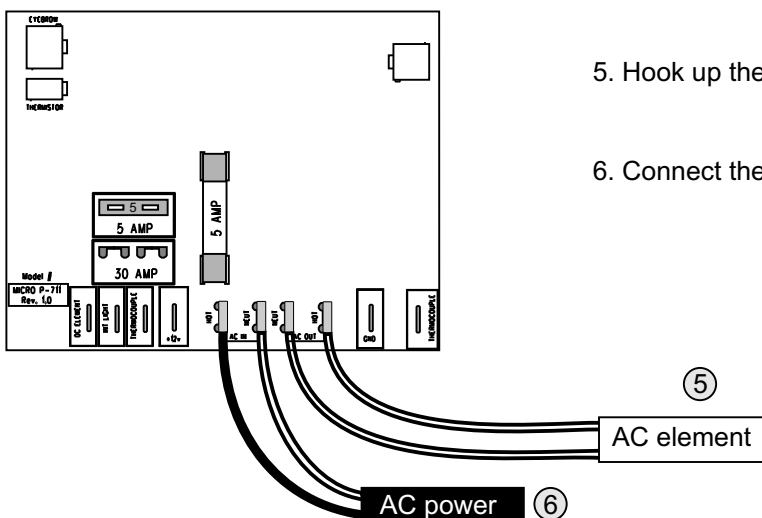

5. Hook up the AC element.

6. Connect the AC supply to the board.

3-way Installation

(3-way refrigerators HAVE DC LIGHT)

1. MAKE SURE THE AC POWER CORD IS UNPLUGGED FIRST
Hook up the Ground wire first (see below).*
2. Hook up the +12v wire.
3. Hook up the interior light.
4. Remove the shipping cap and hook up the DC element.

Then, install the 30 amp fuse (included in box)

For proper 3-way operation, the 30 amp fuse must be installed!

The MICRO P-711 has a additional chassis ground wire attached, which is secured by one of the mounting screws.
(you still need to connect the wire from J10 to GND, as shown below)

*The GND terminal on the MICRO P-711 board MUST be connected to the ground block of the refrigerator. IF THIS GROUND WIRE IS NOT PRESENT, THEN YOU MUST MAKE ONE.

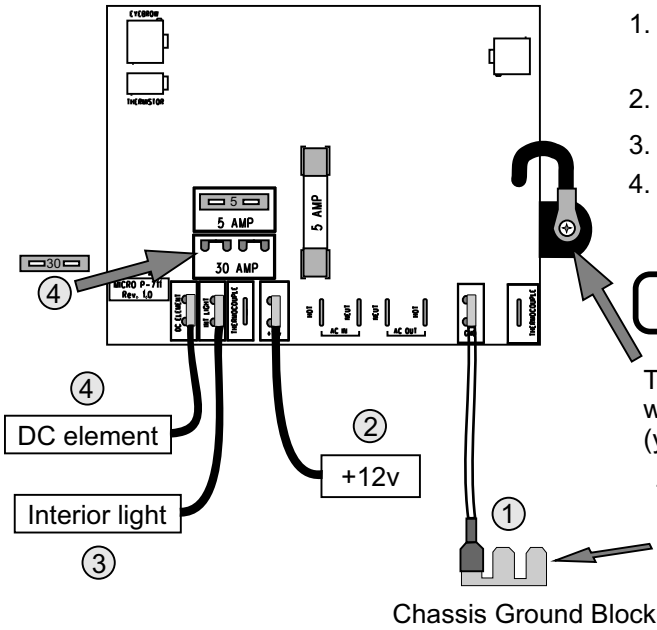

Chassis Ground Block

5. Hook up the thermocouple. Note that both leads connect to the circuit board. HOOK IT UP JUST LIKE THE DRAWING INDICATES.

If the short wire is connected to the chassis ground block, disconnect it and put it on the terminal at the bottom-right corner of the board.

This set-up prevents check light problems caused by ground bounce.

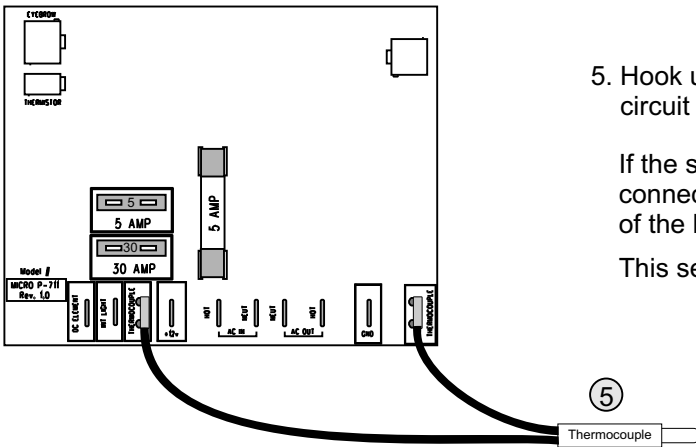

6. Hook up the AC element.

7. Connect the AC supply to the board.

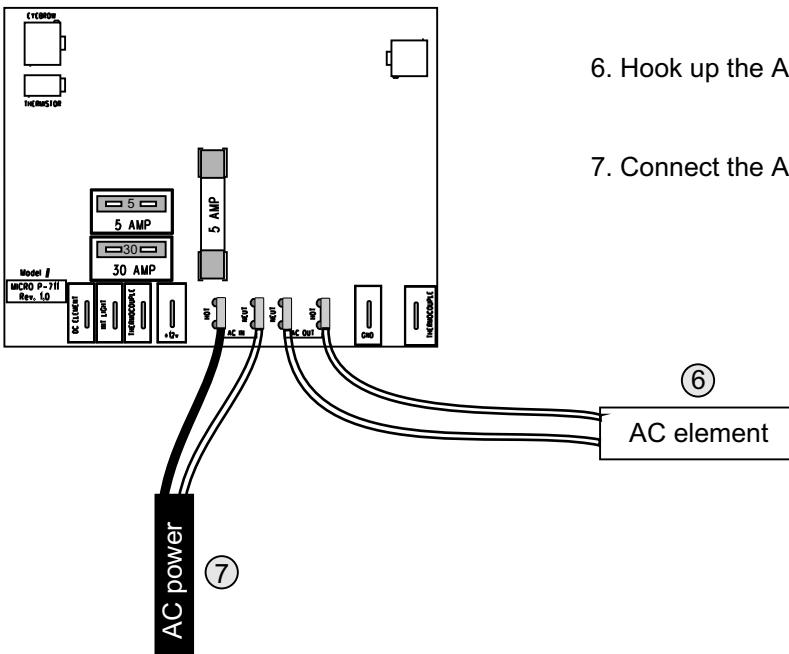

Micro P-711

Features

- 1) **Universal:** Fits 2-way, 3-way, AMES, AES, adjustable-temperature and fixed-temp. refrigerators with the following model #'s:

S 1521, S1531, S 1621, S 1631, S 1821, S1831
NDR1062, NDR1272, NDR1282, NDR1292, NDR1492
RM2551, RM2554
RM 2607, RM 2611, RM 2612, RM 2652
RM 2807, RM 2811, RM 2812, RM 2852
RM 3607, RM 3662, RM 3663
RM 3807, RM 3862, RM 3863
RM 4872, RM 4873
RM 7030, RM 7130, RM 7732, RM 7832

- 2) **Built-in temperature adjustment:** Allows adjustment of operating temperature - especially useful with fixed-temp. refrigerators.
- 3) **Automatic system detection:** Detects the eyebrow type in the refrigerator and automatically selects the proper mode. (some systems use a serial communication link, others use a more simple one-button selector.)
- 4) **Food Saver features: If the eyebrow (communication) fails,** the MICRO P-711 will switch to a special mode that allows it to continue operating as an AC/Gas fixed-temp system. **If the gas operation fails** (check light comes on), the board will re-try every 30 minutes until proper gas operation is restored.
- 5) **Improved thermocouple circuit:** The MICRO P-711 has connections for both thermocouple leads, to eliminate ground bounce problems.
- 6) **Surge protection:** The 12 volt circuits are protected by a fuse and surge absorber from transients and installation errors. (have you ever noticed that the 12v and 120v connectors are side-by-side?)
- 7) **No wiring kit is necessary.** The MICRO P-711 works just as well with the original wiring as with the updated wiring.
- 8) **Connections are clearly marked** - right on the circuit board, so you can properly re-connect it after the paperwork is lost.

Note: The MICRO P-711 is not PAL™ tester compatible.

Dometic “black box” part #'s

2-Way

2931842.01

2931842.02

2931842.03

2931842.04

2932694.017

2932177.01

2932695.01

2932881.01

2932881.010

2932770.01

3-Way

2931843.01

2931843.02

2931843.03

2931843.04

Wire transfer drawing
for 3-way refrigerator.

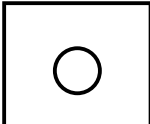

3-Way Dometic Board

J1 J2 J3 J4 J5 J6 J7 J8 J10

MICRO P-711

J1 J2 J3 J4 J5 J6 J7 J8 J10 J11

AC IN AC OUT

DC ELEMENT
INT LIGHT
THERMOCOUPLE
+12v
HOT
NEUT
NEUT
HOT
GND
THERMOCOUPLE
(no equivalent on Dometic board)

Wire transfer drawing for 2-way refrigerator.

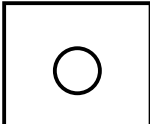

2-Way Dometic Board

J2 J3 J4 J5 J6 J7 J8 J10



MICRO P-711

J1 J2 J3 J4 J5 J6 J7 J8 J10 J11

Not Used
DC ELEMENT

AC IN AC OUT

INT LIGHT
THERMOCOUPLE
+12v
HOT
NEUT
NEUT
HOT
GND
THERMOCOUPLE
(no equivalent on Dometic board)

