



Splendide
TECHNICAL EDUCATION
GROUP PRESENTS



WD2000S (Splendide 2000S)
WD2100 (Splendide 2100)
WDC6200 CEE (Comb-o-matic 6200)
WDC5200 (Comb-o-matic 5200)

Front-Loading Automatic Washer-Dryer

Training Guide

Part No. TRAINMAN

Contact Info

Product Specifications & Warranty Info

Westland Sales, Splendide Tech Dept.
1-800-356-0766 EXT. 5
(503-655-2563)

Technical Assistance & Parts Ordering

Westland Sales, Splendide Tech Dept.
1-800-356-0766 EXT. 5
(503-655-2563)

Literature Orders

Westland Sales, Splendide Tech Dept.
1-800-356-0766 EXT. 5
(503-655-2563)

Corporate Headquarters

15650 SE 102nd Ave.
(PO BOX 427)
Clackamas, OR 97015

Telephone: 800-356-0766 (503-655-2563)

Service Fax: (503) 722-9202

Service E-mail: service@splendide.com

www.splendide.com/support.htm

Introduction

Westland Sales assumes no responsibility for repairs on Splendide products by anyone other than Authorized Splendide Service Technicians. Warranty repairs must be pre-approved by Splendide. Contact Westland Sales, before servicing any Splendide appliance.

This Training Guide for the “Splendide Front-Loading Automatic Washer-Dryer,” (Part No. TRAINMAN), provides the service technician with information on the installation and service of Splendide washer-dryer models WD2100, WD2000S, WDC6200CEE, WDC5200. It is to be used as a supplemental training aid for service technicians. For more information on the washer-dryer, refer to the “Use and Care Guide” provided with the appliance, or the “Service Manual” (Part No. SERVMAN) available separately from Westland Sales.

Training Guide Goals

The goal of this Training Guide is to provide information that will enable the service technician to properly diagnose malfunctions and repair the Splendide Front-Loading Automatic Washer-Dryer.

The objectives of this Training Guide are for the service technician to:

- Understand and follow proper safety precautions.
- Effectively troubleshoot and diagnose malfunctions.
- Successfully perform necessary repairs.
- Help the technician to quickly return the washer-dryer to its proper operational status.

Splendide®

© Copyright 2004, Westland Sales, Clackamas, OR 97015

Contents

1. General Information	1	
Model / Serial Number Designators		1
Warranty Guide		2
Washer-Dryer Specifications		3
IMPORTANT General Safety Information		4
2. Installation Information	5	
Installation Requirements		5
Installation Instructions		9
3. Theory of Operation	13	
Introduction to the Models		13
Water System		13
Wash/Dry System		15
Door Lock / Switch Assembly		17
Suspension System		17
Customer Interface / Cycle Selection System		18
Automatic Routines		24
4. Accessing the Components	27	
Component Locations		27
Top Panel / Control Panel Components		28
Door / Door Switch / Porthole Diaphragm		29
Detergent Dispenser Assembly / Water Valves		31
Pressure Switch		32
Fan Motor / ECO's / Heater Coil & Housing		33
Lower Panel / Drain Pump / Pump Filter		35
Back Panel / Main Motor / Module Board		37
Shock Absorbers		38

(Continued on the next page)

5. Component Testing Procedures	41	
Connector Locations on the Module Board		41
Introduction / Instructions		42
1. Door Switch Test		43
2. Power “in” from the Surge Protector Test		44
3. Pressure Switch Test		45
4. Heating Element Test		46
5. Main Motor Test (<i>Includes Running the Main Motor with AC Voltage</i>)		47
6. Fan Motor / Water Pump Test		48
7. Water Valve Test		49
8. Push Buttons, Dry Time & Temp. Selector Tests		50
9. Cycle Selector Test		53
10. NTC Sensor / LED’s Tests		54
6. Diagnosis & Troubleshooting	55	
Introduction		55
Explanation of Fault Codes		55
Fault Code / Testing Procedure Chart		56
Problem / Testing Procedure Chart		58
7. Tech Tips	60	
Manually Unlocking the Door		60
Opening the Door if the Handle is Broken		60
Performing a Dryer Airflow & Heat Test		60
Winterization Instructions / Optional RV Winterization		61
Verifying Normal Operation		62
8. Wiring Diagrams	63	
WD2100 / WD2000S (<i>Splendide 2100 / Splendide 2000S</i>)		63
WDC6200CEE / WDC5200 (<i>Comb-o-matic 6200 / Comb-o-matic 5200</i>)		64

General Information

Model / Serial No. Designators

Use these numbers to obtain the Warranty status as well as a history of repairs and service calls for the washer-dryer.
To speed the repair process, ALWAYS have the Model and Serial No. ready when you call Westland Sales.

Model Number	WD	C	6200CEE
PRODUCT GROUP WD = Washer-Dryer			
PRODUCT IDENTIFICATION C = Condenser Drying System (Ventless model)			
DRUM VOLUME CODE 2000S & 5200 = 1.6 cu. ft. 2100 & 6200 = 1.92 cu. ft.			

Serial Number	S/N	3	07	14	3277
YEAR OF MANUFACTURE					
MONTH OF MANUFACTURE					
DAY OF MANUFACTURE					
PRODUCT SEQUENCE NUMBER					

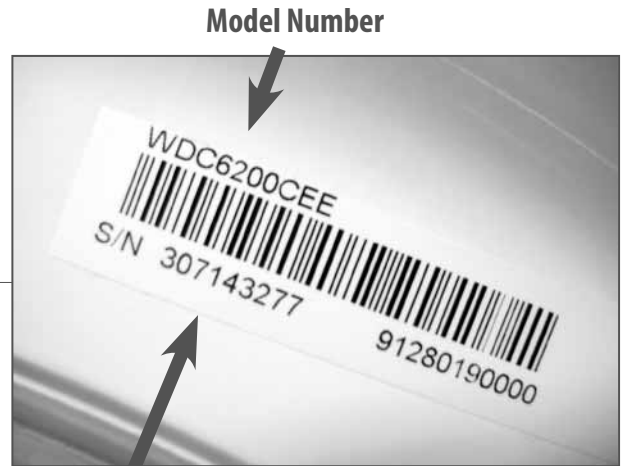

Warranty Guide*

Refer to this page for a brief summary of the Product Warranties available by Splendide.

Wty Length	Splendide Will Pay For	Splendide WILL NOT Pay For
<p>MFR 1-YEAR From Date of Purchase</p>	Replacement parts ONLY.	<p>A. Repairs when the washer-dryer is used in other than normal, single-family use.</p> <p>B. Pickup and delivery. The washer-dryer is designed to be repaired on-site.</p> <p>C. Removal/replacement of washer-dryer from built-in or cabinet installations.</p>
<p>LIMITED 2-YEAR From Date of Purchase (Not available for some models)</p>	For two years from the date of purchase WHEN product is registered. Limited replacement parts and repair labor costs. Coverage starts 60 days after the completed warranty registration card is received by Westland Sales.	<p>D. Damage to the washer-dryer caused by accident, alterations, misuse, abuse, fire, flood, acts of God, or use of products not approved by Splendide.</p> <p>E. Repairs to parts or systems resulting from unauthorized modifications made to the washer-dryer.</p>
<p>LIMITED 5-YEAR From Date of Purchase (Not available for some models)</p>	For five years from the date of purchase WHEN extended Protection Plan is purchased. Limited replacement parts and repair labor costs. Coverage starts 60 days after the full payment is received by Westland Sales.	<p>F. Replacement parts or repair labor costs not pre-approved by Splendide and/or provided by an unauthorized service company.</p> <p>G. Service calls to correct the installation of the washer or to instruct you how to use it.</p> <p>H. Plastic parts and cosmetic pieces.*</p>

*IMPORTANT!

This chart should be used ONLY as a guide and DOES NOT supersede the Warranty Statement. For complete information, refer to the Warranty Statement that came with the appliance.

Washer-Dryer Specifications

The following is a list of product specifications for the Splendide Models covered in this Training Guide.

Model Number	WD2100	WD2000S	WDC6200CEE	WDC5200
COLOR	White	White	White	White
DRYER TYPE	Vented	Vented	Ventless	Ventless
ELECTRICAL REQ.				
Max. Current	13A	13A	13A	13A
Rated Current	15 A	15 A	15 A	15 A
Voltage	120V	120V	120V	120V
Frequency	60Hz	60Hz	60Hz	60Hz
Heating Power	1300W	1300W	1300W	1300W
GALLONS WATER/Reg. Cotton Heavy Duty Cycle*	7.5 Gal.	7.5 Gal.	7.5 Gal.	7.5 Gal.
CAPACITY				
Wash	12 lb.	10 lb.	12 lb.	10 lb.
Dry	8 lb.	6 lb.	8 lb.	6 lb.
MAX SPIN SPEED	1200 RPM	1200 RPM	1200 RPM	1200 RPM
Height	33 1/4"	33 1/4"	33 1/4"	33 1/4"
Width	23 1/2"	23 1/2"	23 1/2"	23 1/2"
Depth	23 3/8"	22 3/16"	24 1/4"	18 1/4"
WEIGHT	161 lb.	150 lb.	161 lb.	139 lb.
PROGRAMS				
Wash	9 Cycles	9 Cycles	9 Cycles	9 Cycles
Dry	3 Cycles	3 Cycles	3 Cycles	3 Cycles
WASH TEMP OPTIONS	7	7	7	7
SPECIAL WASH OPTIONS	5 buttons	5 buttons	5 buttons	5 buttons

*Avg. wash water use is 9-16 gal/wash load. Water usage varies depending on load size and fabric type.

NOTE: WDC6200CEE and WDC5200 models have condenser (ventless) drying systems. Condenser drying systems use 5 gallons of cold water per hour during the dry cycle.

IMPORTANT General Safety Information



Your safety is important. Read this section before you continue.



Important safety messages can be found in this manual and on the appliance. Always read and obey all safety messages.





This is a safety alert symbol. This symbol alerts you to potential hazards that can kill or hurt you and others. All safety messages will follow the safety alert symbol and the word "WARNING."

The safety messages will tell you what the potential hazard is, tell you how to reduce the chance of injury, and tell you what can happen if the instructions are not followed.

 WARNING	
	ELECTRICAL SHOCK HAZARD Disconnect power before servicing. Replace all panels before operating. Failure to do so can result in death or electrical shock.

 WARNING	
	EXCESSIVE WEIGHT HAZARD Use two or more people to move and install the washer-dryer. Failure to do so can result in back or other injury

 WARNING	
	ELECTRICAL SHOCK HAZARD Plug washer-dryer into a grounded 3 prong outlet. Do not remove ground prong. Do not use adapter. Do not use an extension cord. Failure to follow these instructions can result in death, fire, or electrical shock.

Electrostatic Discharge (ESD)

Sensitive Electronics

ESD problems are present everywhere. ESD may damage or weaken the electronic control assembly. The new control assembly may appear to work well after repair is finished, but failure may occur at a later date due to ESD stress.

- Use an antistatic wrist strap. Connect the wrist strap to a green ground connection point or unpainted metal in the appliance; or touch your finger repeatedly to a green ground connection point or unpainted metal in the appliance.
- Avoid touching electronic parts or terminal contacts. Handle the Module Board by the plastic housing ONLY.

Installation Information

Installation Requirements

Check these location, plumbing and electrical installation requirements for a proper washer-dryer installation.

Tools and Parts

Assemble the necessary tools and supplies before beginning the washer installation. The parts supplied are in the drum.

Tools needed for installation:

Wrench, Screwdriver, 13mm Socket/Ratchet

Parts Supplied



U-Clamp



Transit Bolt Hole Plugs (4)

If You Have	You'll Need to Buy
No access to Hot/Cold water hookups	Splendide Faucet Adapter Kit, Part No.154187104A (8ft , 2.4m)
Vented Drying Model	Splendide Vent Kit, Part No. VI-422, VID-401, or similar
Water Damage Concerns	Splendide Drain-A-Way Pan, Part No. PI-22, PI-24, or similar
Floor Drain	Siphon break kit (Sold at hardware stores)
Disposer Drain	"Y" connector (Sold at hardware stores)

Location

Selecting the proper location for the washer-dryer improves performance and minimizes noise. Proper installation is your responsibility.

The washer-dryer can be installed under a counter, in a closet, in an alcove, or in a recessed area with minimum installation clearances of 0" sides, 1" front/back.

You'll Need

- A water heater set to deliver 120°F (49°C) water to the washer
- A grounded electrical outlet located within 6 ft. (1.8 m) of where the power cord is attached to the back of the washer. (See "Electrical Requirements.")
- Hot and cold water faucets located within 8ft. (2.4 m) of the hot and cold water fill valves, and water pressure of 7.5-100 psi.
- A solid, level floor that can support at least 280 lbs. (127 kg). DO NOT install on carpet.
- **RV/Marine Installations:** Position the machine over the axles or mid-ship and block-in to prevent extreme movement.
- **Vented models:** Rigid or flex/metal dryer ducting. The washer-dryer MUST be exhausted to the OUTSIDE. Exhaust ducts should be as short and straight as possible and must slope downwards and away from the machine. The exhaust duct must end with an approved exhaust vent hood with swing out damper(s) or tailpiece with louvers.

(Continued on the next page)

Washer-Dryer Dimensions

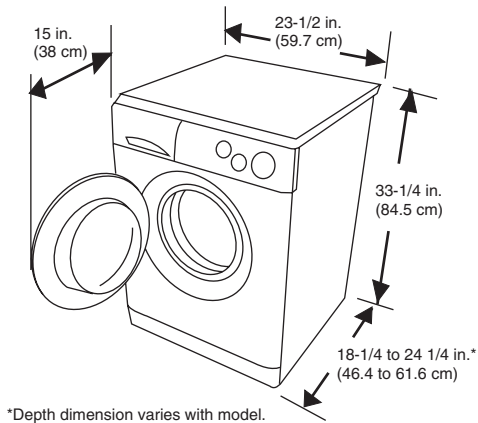

Undercounter Install Requirements

The dimensions shown are for the minimum spacing allowed.

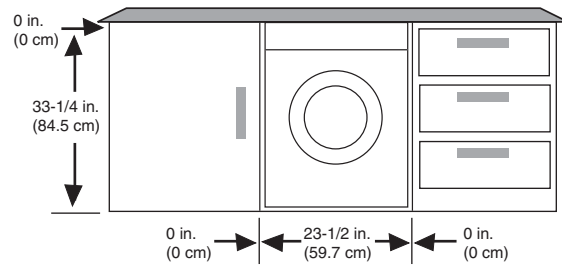

Recessed Area/Closet Install Requirements

The dimensions shown are for the minimum spacing allowed.

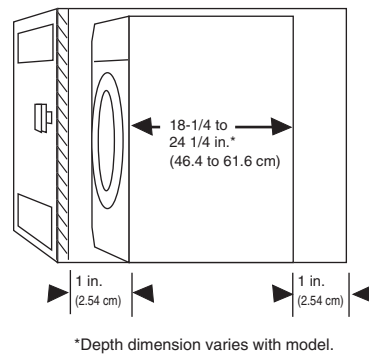

Additional spacing should be considered for:

- Ease of installation and servicing.
- Additional clearances might be required for wall, door and floor moldings.
- If cabinet door is installed, a minimum of 8 sq. in. should be provided for make up air. Louvered doors with equivalent air openings are acceptable.

Drain System Requirements

The washer-dryer can be installed using the standpipe drain system, floor drain system or the sink drain system. To prevent siphoning, the outlet end of the drain hose **MUST** always be 20" (50.8 cm) above the base of the machine. Not more than 6" (15.24 cm) of the drain hose should be inserted into the drain pipe.

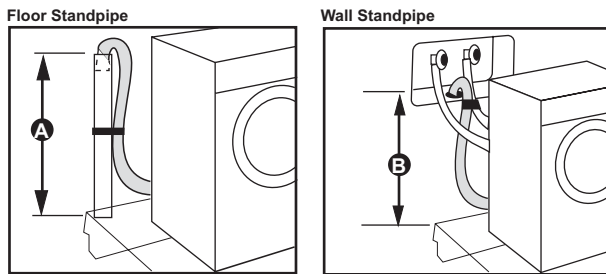

A & B = 25" (62 cm) min. / 34" (86 cm) max.

The standpipe drain requires a minimum diameter standpipe of 1-1/4" (3.2 cm). The minimum carry-away capacity can be no less than 7 gal (26.5 L) per minute.

The top of the standpipe must be at least 25 in. (62 cm) high and no higher than 34" (86 cm) from the bottom of the washer.

The floor drain system requires a siphon break that may be purchased separately.

The sink drain system connected to a garbage disposer requires a "Y" connector (sold separately).

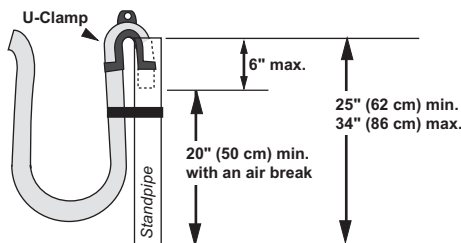

Sink Drain W/ "Y" Branch Tailpiece

Laundry Sink Drain

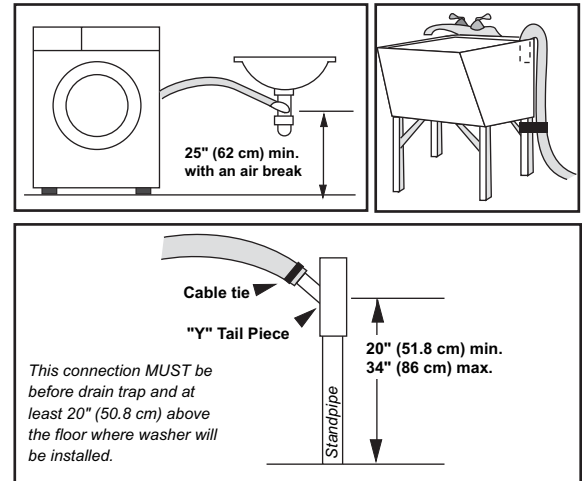

Floor Standpipe w/ "Y" Branch Tail Piece

Optional

- The Splendide Faucet Adapter Kit, Part No. 154187104A
- Supplies water from the faucet and discharges water directly into the sink.
- Designed for installations where washer-dryer hookups are not available.



Faucet Adapter Kit, Part No. 154187104A

(Continued on the next page)

Electrical Requirements

GROUNDING INSTRUCTIONS

This appliance must be grounded. In the event of a malfunction, or breakdown, grounding will reduce the risk of electric shock by providing a path of least resistance for electric current. This appliance is equipped with a cord having an equipment grounding conductor and grounding plug. The plug must be plugged into an appropriate outlet that is properly installed and grounded in accordance with all local codes and ordinances. **DO NOT** modify the plug provided with the appliance. If it will not fit the outlet, have the proper outlet installed by a qualified electrician.

WARNING: Improper connection of the equipment-grounding conductor can result in a risk of electric shock. Check with a qualified electrician or serviceman if you are in doubt as to whether the appliance is properly grounded.

WARNING



ELECTRICAL SHOCK HAZARD

Plug washer-dryer into a grounded 3 prong outlet.

Do not remove ground prong.

Do not use adapter.

Do not use an extension cord.

Failure to follow these instructions can result in death, fire, or electrical shock.

- A 120-volt, 60-Hz., AC-only, 15 or 20-amp, fused electrical supply is required. Time-delay fuse or circuit breaker is recommended. It is recommended that a separate circuit serving only this appliance be provided.
- This washer-dryer is equipped with a power supply cord having a 3-prong ground plug.
- To minimize possible shock hazard, the cord must be plugged into a mating, 3-prong, ground-type outlet, grounded in accordance with local codes and ordinances. If a mating outlet is not available, it is the personal responsibility and obligation of the customer to have the properly grounded outlet installed by a qualified electrician.
- If codes permit and a separate ground wire is used, it is recommended that a qualified electrician determine that the ground path is adequate.
- Do not ground to a gas pipe.
- Check with a qualified electrician if you are not sure the washer is properly grounded.
- **DO NOT** use an extension cord.
- Do not have a fuse in the neutral or ground circuit.
- **DO NOT** install or store this appliance where it will be exposed to weather or in an area where gasoline or other flammables are stored.

Installation Instructions

Follow these instructions in order to prevent installation errors and to assure proper washer-dryer operation.

! WARNING	
	<p>EXCESSIVE WEIGHT HAZARD</p> <p>Use two or more people to move and install the washer-dryer.</p> <p>Failure to do so can result in back or other injury</p>

Route the Drain Hose

Proper routing of the drain hose protects your floors from damage due to water leakage. Carefully read and follow these instructions.

The drain hose is connected to the washer:

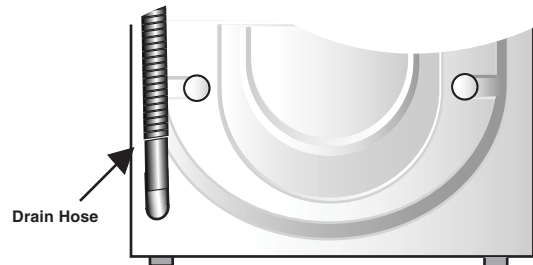

Remove the Transit Screws/Spacers

First, position the washer so that the rear of the unit is within approximately 3 feet (90 cm) of the final location. There are 4 bolts in the rear panel of the washer that support the suspension system during transportation.

1. Using a 13mm socket, loosen each of the bolts.
2. Once loosened, pull out the bolt, including the rubber grommet and the plastic spacer covering the bolt.

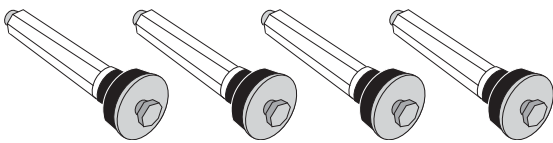
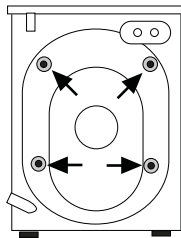

3. Once all 4 bolts are removed, close the holes with the transit bolt hole plugs (provided).
4. Keep the bolts, rubber grommets and plastic spacers in a safe place. These items should be reinstalled if the machine is transported in the future.

To prevent drain water from going back into the washer:

- Do not straighten the drain hose, and do not force excess drain hose into the standpipe. Hose should be secure, but loose enough to provide a gap for air.
- When routing the drain hose through cabinets or walls, use a protective material such as electrical tape to cover sharp edges that could damage the hose.

Connect the Inlet Hoses

Before connecting any hoses, run the faucets until the water is clear to remove any debris. Make sure the drum is empty.

1. Connect the angled ends of the hoses to the inlet valves at the back of the machine (20mm threads). Screw on the couplings

(Continued on the next page)

by hand until they are seated on each gasket.

2. Attach the hose connected to the 'H' valve to the hot water faucet. Screw on the coupling by hand until it is seated on the gasket. DO NOT OVERTIGHTEN.

3. Attach the hose connected to the 'C' valve to the cold water faucet. Screw on the coupling by hand until it is seated on the gasket. DO NOT OVERTIGHTEN.

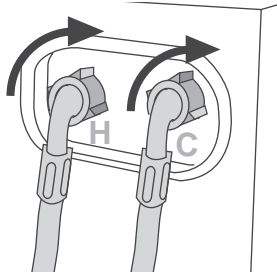

4. Turn on the water faucets and check for leaks.

Secure the Drain Hose

1. Drape the power cord over the washer top.
2. Secure the drain hose to the laundry tub leg or standpipe with a strap or cable-tie.

IMPORTANT!

Replace the inlet hoses after 5-years of use to reduce the risk of hose failure. Record hose installation or replacement dates on the hoses for future reference. Periodically inspect and replace hoses if bulges, kinks, cuts, wear, or leaks are found.

3. Use the U-Clamp (provided) and insert the drain hose into the standpipe or sink. **DO NOT force excess drain hose into the standpipe. There should be only 6" of drain hose in the stand pipe.**

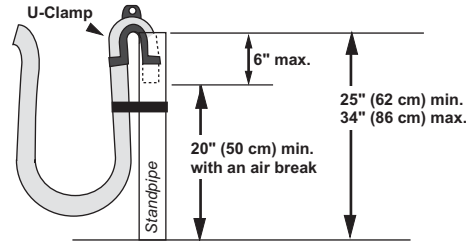

Level the Washer-Dryer

Properly leveling the washer-dryer, prevents excessive noise and vibration.

1. Tilt the machine back, leaning it against the wall.
2. Adjust the legs up or down to ensure the washer is resting solid and does not rock side-to-side or front-to-back when the machine is upright.

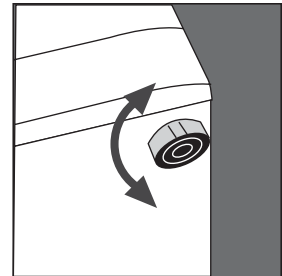

Install Dryer Ducting WD2100/WD2000S

These models must be vented to the outside. Proper routing of the dryer ducting increases drying efficiency and prevents safety hazards.

1. The rigid or flex/metal ducting should slope downward and away from the machine. After determining the shortest, straightest ducting route, cut a 4" diameter hole through the wall to the outside.



Splendide VI-422 Vent Kit

2. Follow the manufacturers instructions to install a louvered vent or flap and tailpiece (sold separately) to the wall.

3. Use duct tape or screw clamps to secure the ducting to the tailpiece and to the vent flange on the back of the machine.

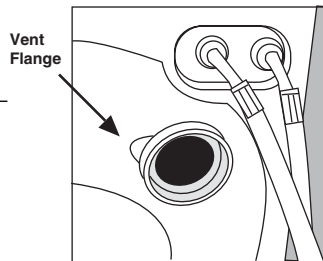

Complete the Installation



- Check the electrical requirements. Be sure that you have the correct electrical supply and the recommended grounding method. (See "Electrical Requirements.")
- Check to be sure all parts are now installed. If there's an extra part, go back through the steps to see which step was skipped.
- Check to be sure you have all your tools.
- Dispose/recycle all packaging materials.
- Check to be sure all water faucets are on.
- Check for leaks around faucets and inlet hoses.
- Plug into a grounded 3-prong outlet.
- Slide the washer-dryer to it's final location and confirm that it's level.
- Read "Use & Care Manual"

To test and clean the washer, measure 1 to 2 tbsp. of powdered High Efficiency (HE) detergent.

- Pour the detergent into the dispenser.
- Select EXPRESS in the COTTON HEAVY DUTY CYCLE.
- Then press ON. Allow the washer to complete one full cycle.



Splendide All-Natural Premium HE Laundry Powder, Part No. 1005 - Available from Splendide

 WARNING	
	ELECTRICAL SHOCK HAZARD
	Plug washer-dryer into a grounded 3 prong outlet.
	Do not remove ground prong.
	Do not use adapter.
	Do not use an extension cord.
	Failure to follow these instructions can result in death, fire, or electrical shock.

NOTES:

Theory of Operation

Introduction

The Splendide Front-Loading Washer-Dryer models present many new features and characteristics that are different from previous models. In addition to the introduction of electronic controls, the washer-dryer contains a number of unique operating features designed to offer extremely high water and energy conservation while increasing fabric cleaning results.

Water System

The water system consists of the hot and cold water inlet valves and the dispenser distribution system along with a traditional pressure switch.

Water Inlet Valves

The hot and cold water inlet valves are located at the back, top-left of the washer. These valves receive a control signal from the Module Board to manage the temperature of incoming water. The temperatures are determined by the specific wash temperature selected. (See chart on next page)

Dispenser Distribution System

All wash and rinse water is introduced into the drum through a Dispenser Distribution System that diverts the incoming water to one or more of the follow water inlet modes: Detergent Dispensing, Bleach Dispensing, Fabric Softener Dispensing. The dispenser drawer has three separate compartments (plus one removable bin) for adding laundry products to the wash load. These compartments are:

1. Prewash Detergent (w/re-movable Bleach Bin)
2. Main Wash Detergent
3. Fabric Softener Compartment

All of the water flows through the dispenser assembly. Laundry products are diluted and dispensed automatically at the proper time during the wash cycle. Refer to "Use and Care Guide" that came with the appliance for proper use of laundry aids.

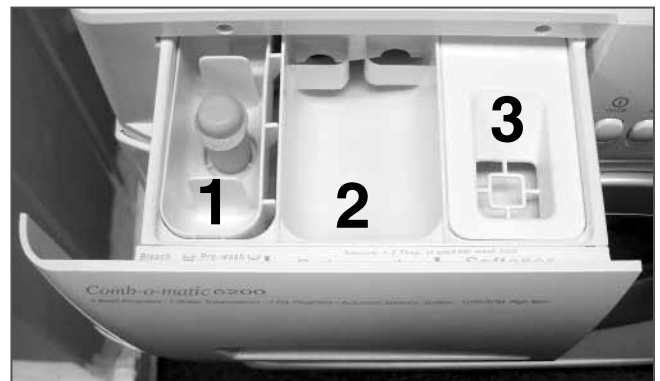

Dispenser Drawer

Pressure Switch

The pressure switch is located in the top, right-front corner of the washer. This switch senses the water level in the drum. The control signal from the pressure switch is sent to the Module Board and is used to determine the amount of water introduced into the drum during the wash cycle.

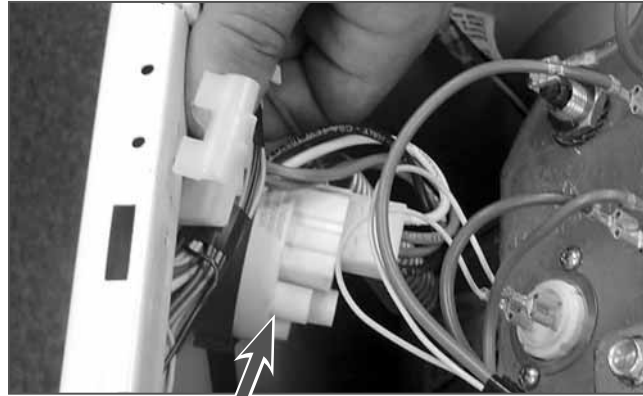

Pressure Switch

WASH TEMP Knob	Position	Wash Temp.*
HOT (Red)	1:30	140°F / 60° C
	3 o'clock	131°F / 55° C
WARM (Grey)	4:30	122°F / 50° C
	6 o'clock	104°F / 40° C
	7:30	95°F / 35° C
COLD (Blue)	9 o'clock	86°F / 30° C
	10:30	FROM COLD VALVE ONLY
	12 o'clock	FROM COLD VALVE ONLY

**NOTE: Actual wash water temperatures may vary depending on the temperature set at the water heater. Rinse temperatures are ALWAYS COLD.*

Wash/Dry System

The Wash/Dry System consists of the Module Board, the Main Motor, the Pump Motor and the Dryer Heating Element.

Module Board

The Module Board is located at the bottom, right-rear corner of the washer-dryer. If diagnostic tests indicate that the module board is defective, the entire module board must be replaced.

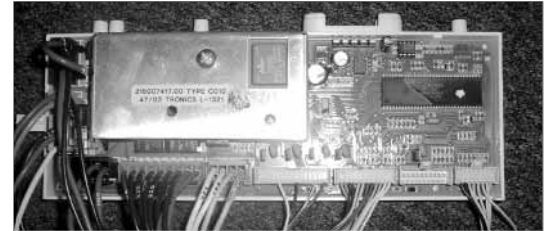

The module board receives input from the Control Panel/LED assembly and directly controls the dispenser, drain pump, water inlet valves, door locking and unlocking, fan motor and heating element relay. The module board monitors the pressure switch, and door lock switches.

Main Motor

The main motor is located at the bottom, rear of the washer and is an infinite speed 0-90 VDC motor that operates at various speeds and directions based on input voltages from the module board.

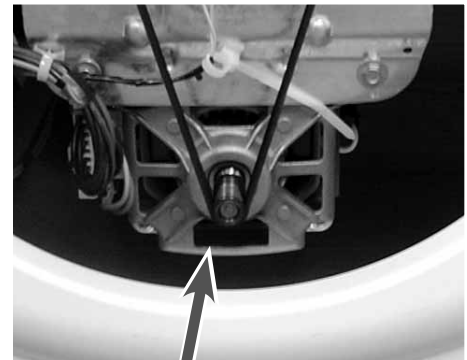

Main Motor

(Continued on the next page)

Pump Motor

A separate pump/pump motor is used to drain the drum (Fig. 3-1). The pump motor is 120 VAC and is attached directly to the pump. The pump has a filter located at the bottom-front that allows for the removal of large objects like keys and coins that may have passed from the basket. (Fig. 3-2)



Fig. 3-1

Drain Pump



Fig. 3-2

Large Object Filter

Dryer Heating Element

The Dryer Heating Element is located in the heater duct assembly on the top-right of the drum. The Module Board provides power to the element in the dry cycle. During the dry cycle:

- **Vented models** (WD2100 and WD2000S) take air from the surrounding room, heat it, tumble it through the clothes, and then exhaust it to the outside through a vent.
- **Ventless models** (WDC6200CEE and WDC5200) require 5 gallons of cold water per hour during the dry cycle. (See below.)

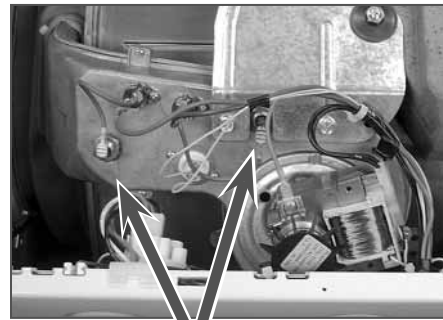

Dryer Heating Element

How Does Ventless Drying Work?

1. As damp laundry tumbles, the inner drum is heated. Heat draws the moisture out of the laundry in the form of STEAM.
2. Cold water cools the OUTER TUB. The cold surface attracts the warm, saturated air. STEAM passes through the holes in the INNER DRUM to reach the OUTER TUB.
3. When the STEAM hits the cooled surface of the OUTER TUB, it's condensed back into water. The water is then pumped out the drain. Process repeats until clothes are dry.

NOTE: Do not attempt to dry less than 2.2 lbs of laundry during the Cotton Heavy Duty Dry cycle.

Door Lock/Switch Assembly

The Door Lock/Switch Assembly is located on the right side of the door opening. The assembly contains a bi-metal operated latching mechanism that will electrically lock the door during a wash or dry cycle.

Door Lock/Switch Assembly



Suspension System

The drum assembly is held in position with two shock absorbers attached to the bottom sides of the tub assembly. In addition, the drum is suspended from the top frame of the washer with three springs attached to the sides of the case.

Stability for this suspension system is provided by two concrete counter weights. One is located at the top and one at the bottom-front of the outer drum.

Springs

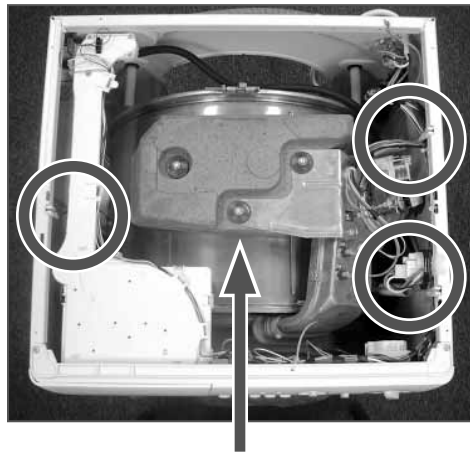

Top Counter Weight



Bottom/Front Counter Weight

Shock Absorbers

Customer Interface / Cycle Selection System

The Customer Interface / Cycle Selection System consists of the Control Panel/LED Assembly along with the program timer, option buttons, and Wash Temperature and Dry Time Selectors.

Control Panel/LED Assembly

The Control Panel/LED Assembly (Fig. 3-3) is removed as a single assembly and is connected to the Module Board by 14 connection points to the wiring harness.

The assembly contains all the buttons, LED's and switches for the user to operate the washer-dryer. This interfaces what the consumer commands to the Module Board.

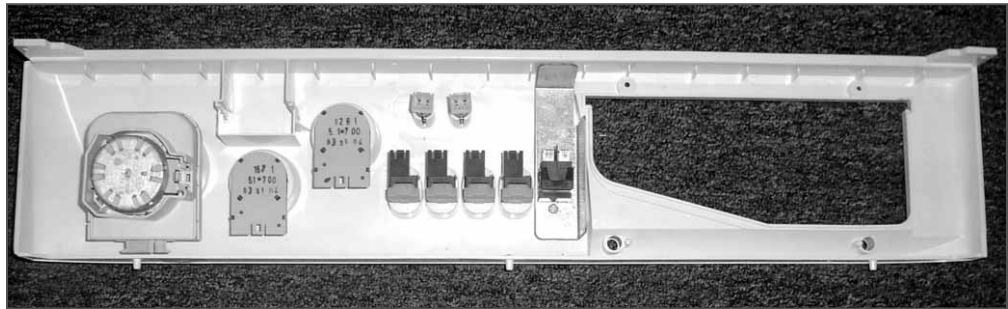

Fig. 3-3

NOTE: *Knobs, Selectors and LED's are not shipped with the replacement Control/Panel LED Assembly.*

Description of Control Panel Buttons, Knobs & LED's

ON/OFF Button- Leave the ON/OFF button in the OFF (out) position while setting the controls, then press ON (in) to start the program.

Option Buttons - Use these buttons to modify the wash cycle (see "Description of Option Buttons")

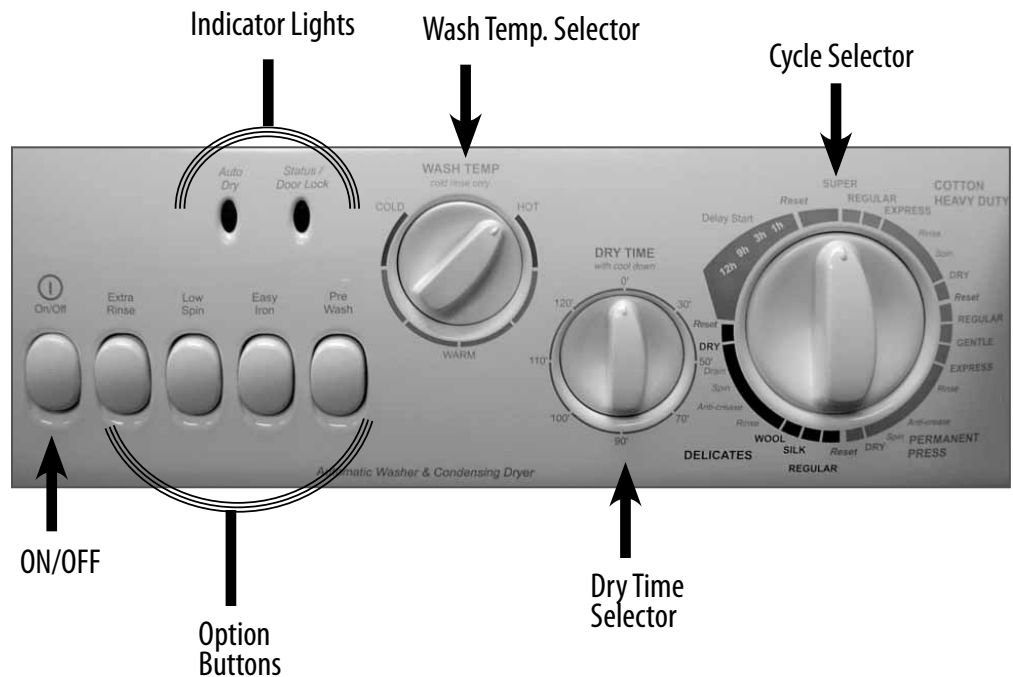

Status/Door Lock Light - This light indicates when the door is locked (solid or rapid flash) and when it can be safely opened (SLOW flash).

Auto Dry Light - This light indicates when a dry time has been set.

Water Temperature Selector - Choose a water temperature by turning the knob to the desired selection. Refer to the garment label and choose the warmest water safe for the fabric. Choose a slightly lower temperature to get the same wash results while saving energy. NOTE: Rinse is always COLD.

Dry Time Selector - Choose a dry time by turning the knob to the desired selection. Choose No Dry ("0" min) up to 120 min. This knob does not move during the dry cycle.

Cycle Selector - Choose a wash cycle or dry cycle by turning the knob to the desired cycle. Each cycle is designed for different types of fabric and soil levels.

(Continued on the next page)

Description of Cycle Selector Options

Reset Positions - Choosing a Reset position on the Cycle Selector and waiting 10 seconds will allow changing any option or cycle after the cycle has begun. To cancel a cycle and select a new one, advance the timer to a Reset position, wait 10 seconds (Status/Door Lock light will blink RAPIDLY), then advance the timer to the desired cycle.

Delay Start - Use Delay Start to delay the start of any wash cycle by 1, 3, 9, or 12 hours. With the machine OFF:

1. Advance the cycle selector to 1, 3, 9, or 12 hrs.
2. Press the ON/OFF button ON (in)
3. After 5 seconds, advance the timer to your desired wash cycle. The Status/Door Lock light will blink 2 seconds ON/4 seconds OFF to let you know that Delay Start has been set.

Rinses and Drains - Use a Rinse cycle to get a rinse and spin only. A Rinse is useful for loads that need rinsing only or for adding fabric softener to a load. Use the Drain cycle (In the Delicates section) to drain the washer-dryer.

Description of Option Buttons

You can customize the wash by adding an OPTION or combination of options to your cycle selection. You can add or change the options after starting a cycle anytime before the option begins. (See "Preset Wash/Dry Cycles Chart")

Extra Rinse - Pressing this button will add an extra rinse cycle (Not available in Delicates)

Low Spin - Pressing this button will reduce the spin speed to 600 rpm (Not available in Delicates)

Easy Iron - If the Dry Time is "0" min, pressing this button will add more water, reduce the spin, and stops the cycle on "anti-crease". Pressing it again (out) will complete the cycle and allow you to remove clothes promptly so there's less wrinkling. (Available in all Permanent Press cycles and the Silk cycle)

Pre-Wash - Pressing this button will add an extra fill at the beginning of the cycle.

Description of Preset Wash Cycles

Cotton Heavy Duty Wash - Use the Cotton Heavy Duty cycles to wash loads of sturdy, colorfast fabrics and normally to heavily soiled garments. These cycles combine fast speed tumbling and an extra high spin speed (1200 RPM) to shorten dry times.

- SUPER - Use this cycle to wash heavily soiled garments.
- REGULAR - Use this cycle to wash normally soiled garments.
- EXPRESS - Use this cycle to wash smaller loads of lightly soiled garments in less time.

Permanent Press Wash - Use the Permanent Press cycles to wash loads of no-iron fabrics such as sport shirts, blouses, casual business clothes, permanent press blends, linens, and other synthetic fabrics. These cycles combine medium speed tumbling and a high-speed spin (850 RPM) for reduced wrinkling of synthetic fabrics.

- REGULAR - Use this cycle to wash normally to heavily soiled garments.
- GENTLE - Use this cycle to wash lightly soiled garments.
- EXPRESS - Use this cycle to wash smaller loads of lightly soiled garments in less time.

Delicates Wash - Use the Delicates Cycles to wash sheer fabrics, silk, wool, lingerie and other hand washable items. These cycles combine variable speed tumbling and a low spin speed (600 RPM) for gentle fabric care. (Check the label instructions to make sure that the garment is washable.)

- REGULAR - Use this cycle for delicate fabrics.
- SILK - Use this cycle to wash silk items, lingerie, and other particularly delicate fabrics.
- WOOL - Use this cycle to clean washable woolen garments and other hand washables.

How to Set a Wash Cycle:

1. With the machine OFF, select a Wash Cycle
2. Set the Dry Time knob to "0" min.
3. Press "ON"

Description of Preset Dry Cycles

Cotton Heavy Duty Dry - Use this high heat cycle to dry sturdy, colorfast fabrics like towels socks and jeans. There's a high spin at the beginning of this cycle to remove more water from fabrics.

Permanent Press Dry - Use this medium heat cycle to dry certain blouses and casual business clothes.

Delicates Dry - Use this lower heat cycle to dry certain blouses, and casual business clothes.

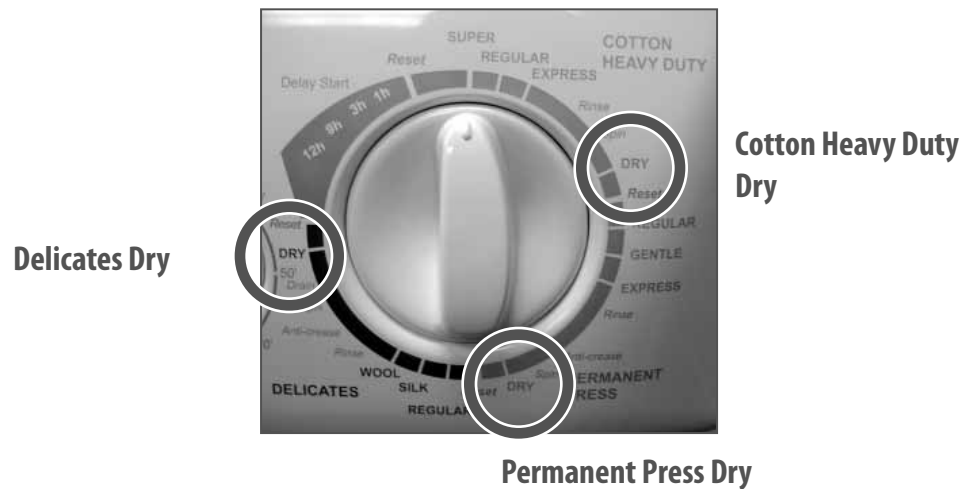

How to Set a Wash Through Dry Cycle:

1. With the machine OFF, select a wash cycle
2. Set the Dry Time knob to the desired time
3. Press "ON". When the wash cycle is finished, the machine will automatically start drying in the preset cycle.

How to Set a Dry Cycle:

1. With the machine OFF, select a Dry Cycle (see above)
2. Set the Dry Time knob to the desired time
3. Press "ON"

Preset Wash/Dry Cycles Chart**

Type of Fabric and Degree of Soil	Program Knob	Detergent For Wash	Fabric Softener	Bleach	Options Available*	Total Length of cycle	Description of Wash Cycle
Cotton Heavy Duty							
Exceptionally soiled whites/colorfast fabrics (Sheets, tablecloths, etc.)	Super	•	•	•	P, L, R	80 min.	35 min. wash cycle, 3 rinse cycles, intermediate and final spin cycles
Heavily soiled whites/colorfast fabrics	Regular	•	•	•	P, L, R	70 min.	27 min. wash cycle, 3 rinse cycles, intermediate and final spin cycles
Slightly soiled whites and light colors (T-Shirts, sweatshirts, etc.)	Express	•	•	•	P, L, R	40 min.	14 min. wash cycle, 2 rinse cycles, intermediate and final spin cycles
Rinse cycles		Softener is automatically dispensed during the last rinse					Rinse cycles, intermediate and final spin cycles
Spin cycle (1200 RPM high spin)							Draining and final spin cycle
Drying cycle for cotton fabrics							Cotton Heavy Duty Dry Program
Reset							Interrupts/cancels program
Permanent Press							
Heavily soiled colorfast synthetics (Baby linen, etc.)	Regular	•	•		P, E, L, R	75 min.	26 min. wash cycle, 3 rinse cycles, anti-crease or spin cycle
Delicate color synthetics (All types of slightly soiled garments)	Gentle	•	•		P, E, L, R	65 min.	19 min. wash cycle, 3 rinse cycles, anti-crease or spin cycle
Delicate color synthetics (All types of slightly soiled garments)	Express	•	•		P, E, L, R	40 min.	13 min. wash cycle, 2 rinse cycles, anti-crease or spin cycle
Rinse cycles		Softener is automatically dispensed during the last rinse					Rinse cycles, anti-crease or spin cycle
Spin cycle (850 RPM spin)							Draining and spin cycle
Drying cycle for synthetic fabrics							Permanent Press Dry Program
Reset							Interrupts/cancels program
Delicates							
Delicates	Regular	•	•		P	65 min.	16 min. wash cycle, 3 rinse cycles, spin cycle
Silk and particularly delicate garments (Curtains, silk, viscose, etc.)	Silk	•	•		P, E	60 min.	17 min. wash cycle, 3 rinse cycles, anti-crease and draining (no spin)
Wool, hand wash	Wool	•	•			45 min.	27 min. wash cycle, 2 rinse cycles, spin cycle
Rinse cycles		Softener is automatically dispensed during the last rinse					Rinse cycles, anti-crease or draining or spin cycle
Spin cycle (600 RPM spin)							Draining and spin cycle
Draining							Draining Only (Silk program)
Drying cycle for synthetic fabrics							Delicates Dry Program
Reset							Interrupts/cancels program
Delay Start							
12 - 9 - 3 - 1 hour delay							Program start is delayed
Stop/Reset							Interrupts/Cancels program

NOTE: You cannot select more than one option for a cycle. Some options cannot be added to some cycles.

**Above cycle times will vary according to water pressure, load size and fabric type.

***Options:**

P = Prewash
E = Easy Iron**
L = Low Spin
R = Extra Rinse

Automatic Routines

The following are routines that the washer-dryer will follow out automatically during all of the wash, spin, rinse and dry cycles.

Door Locking / Unlocking Routines

Door Locking Summary - The Door Locking Routine will only start if the door is securely closed and the Door Switch contact is CLOSED.

1. The Door Switch is energized whenever a cycle is started.
2. During the next few seconds, the contacts on the door switch are checked by the Module Board. The Status/Door Lock light will go SOLID and the cycle will begin.

Door Unlocking Summary - Unlocking will occur ONLY under these conditions:

1. The Main Motor speed equals "0"
2. There is no water in the drum
3. The cycle is finished
4. The Cycle Selector is on a 'Reset' position and the Status/Door Lock light is blinking SLOWLY

IMPORTANT!

- The door WILL NOT open while ANY cycle is in progress (Wash or Dry).
- The door WILL NOT open when the Status/Door Lock light is blinking QUICKLY, or is SOLID.
- The door WILL STAY LOCKED for approximately 1-2 min. after the cycle is complete.

DO NOT attempt to open the door UNLESS the Status/Door Lock light is blinking SLOWLY! If you do, the handle could break and replacement costs would not be covered under the Warranty.

Wash Quality Routines

Drain and Spin Routines - During the Drain and Spin cycles, the water level is checked continuously. Normal Drain and Spin will occur until the Pressure Switch senses no water or foam (suds) in the drum.

Foam Detection and Elimination Routine - Excessive foam can make clothes appear dingy and is usually caused by the use of too much detergent, or the wrong kind of detergent. If the Pressure Switch senses the presence of foam during the Drain or Spin Routine, the Module Board will stop the main motor and the basket will stop spinning. The Drain Pump will turn OFF and the drum will fill with water. Once the tub is filled, the basket will rest for several minutes in an attempt to eliminate the foam before resuming the original cycle. This process will repeat until no foam is detected.

Impulse Spin Technology (IST) - During the Spin cycle the drum will rotate at varying speeds before reaching high spin (instead of a constant pace). This routine optimizes rinse efficiency and drying uniformity - clothing comes out with less creasing and wrinkling.

Automatic Balance Routine

Automatic Balance Routine Summary - An unbalanced load can cause excessive noise and vibration. The Automatic Balance Routine occurs during the distribution ramp (while the basket spin is accelerating from 40 to 600 rpm). At 600 rpm the motor is decelerated and the rate of deceleration is monitored by the Module Board. The motor is then ramped up to 600 rpm and shut off. The rate of deceleration is monitored again and compared to the first deceleration rate. Based on this comparison, the Module Board can determine whether an unbalanced condition exists or not.

- If the Module Board does not sense an unbalanced condition, the ramp will continue.
- If the Module Board senses an unbalance condition, the Main Motor will rotate slowly back and forth for the remainder of the cycle.

NOTES:

Accessing the Components

Component Locations

Follow the instructions in this section to gain access to the following components.

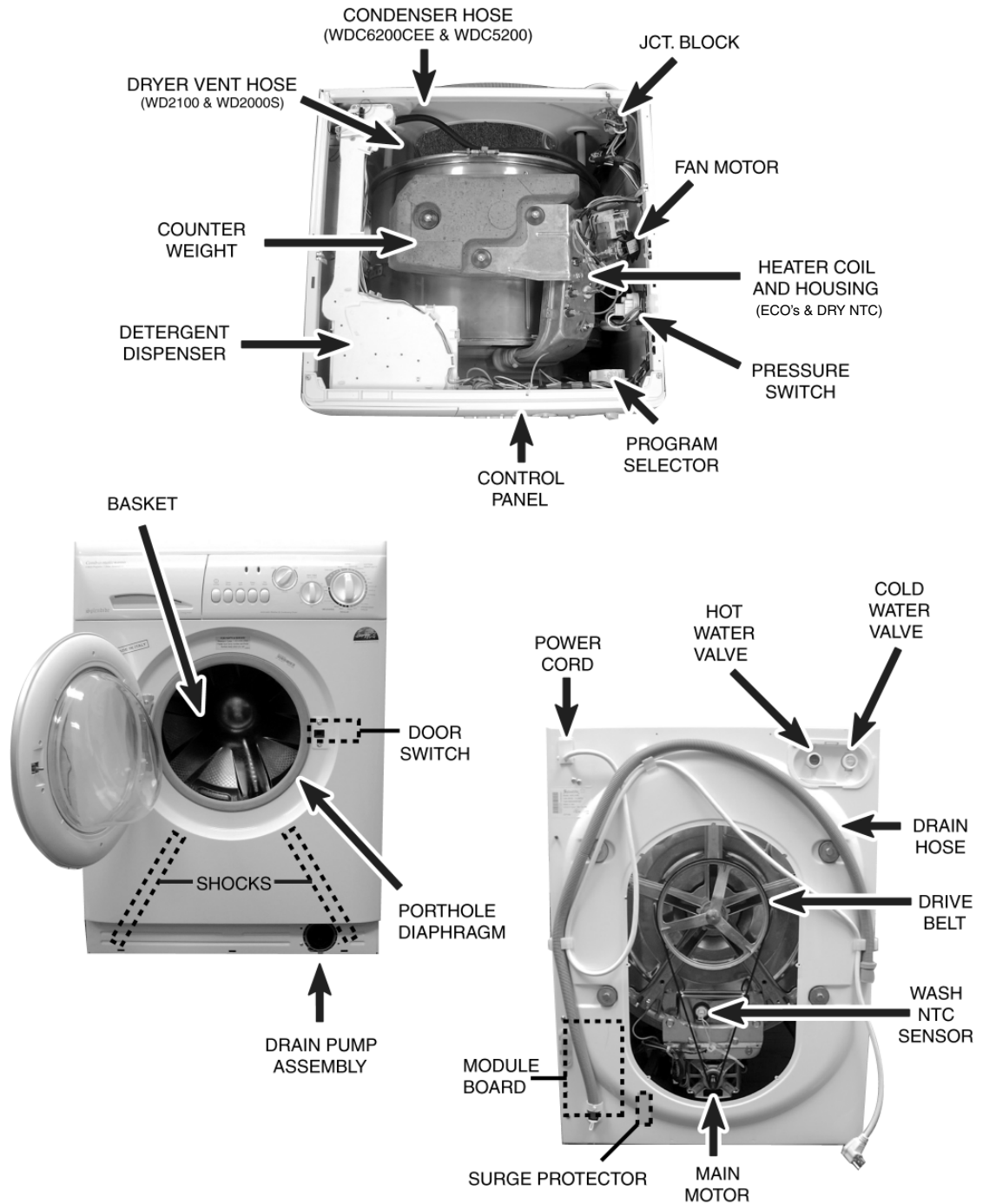

Required Tools

To access components in this washer-dryer, you'll need Metric and Standard sockets of various sizes, Torx-15, 25 Drivers, a Flat Head Screwdriver, and a Phillips Head Screwdriver.

Top Panel / Control Panel Components

Access to the Control Panel requires that the top of the washer be removed.

Removing the Washer-Dryer Top

Two Phillips Head screws secure the main top at the back of the washer-dryer. (Fig. 4-1) Remove these screws and lift straight up on the rear of the main top.

NOTE: *There is a green and yellow ground wire attached to the heat shield on the main top. (Fig. 4-2) This wire will release as you remove the top. Be sure to re-attach it when the top is re-installed.*



Fig. 4-1

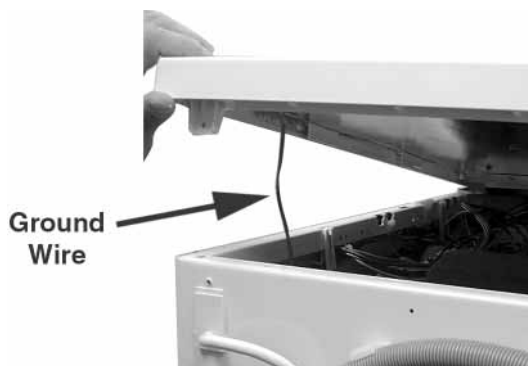
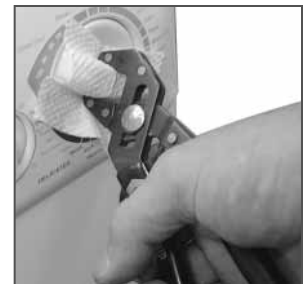

Fig. 4-2

Removing the Knobs

Remove the knob by pulling straight out. If you need to use pliers, make sure to use a shop rag as a buffer, so the knob does not get damaged. (Right)



Removing the Cycle Selector

Depress the tab at the top, center of the recessed area, then lift the selector up and off the mounting brackets. (Fig. 4-3)

NOTE: *Make sure that the wires on the plug correspond to the contacts on the tab of the Selector when re-installed. (Right)*

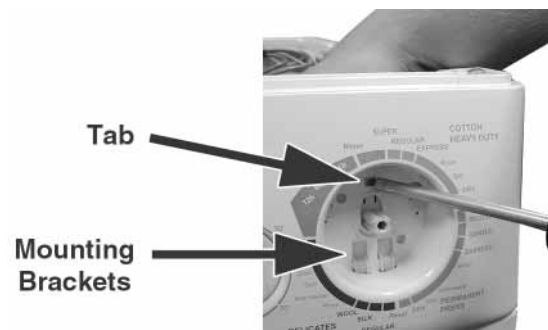
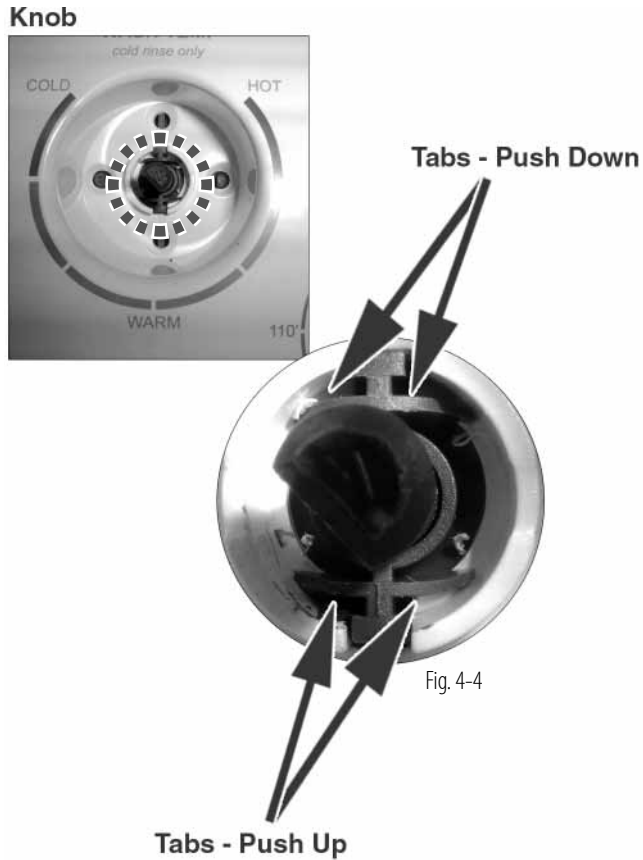

Fig. 4-3

Removing Dry Time/ Water Temp. Selectors

First, mark the connections, so the connectors are attached to the correct Selectors when reinstalled. Push tabs with a screwdriver (Fig. 4-4) while pulling the Selector backwards.



Removing the Control Panel

The replacement Control Panel is shipped as a single unit and contains all switches & buttons (Knobs, Selectors and LED's are not included). Remove the Phillips Head Screws (Fig. 4-5) and then lift the entire panel straight off.

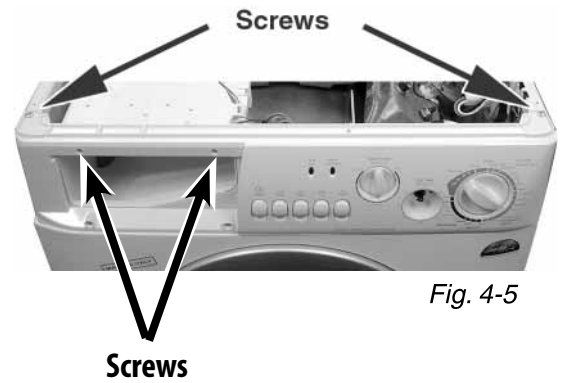

Door / Door Switch / Porthole Diaphragm

Open the Door to access the Door, Door Switch and Porthole Diaphragm.

Removing the Door

Remove the two, size 15 Torx screws that secure the door to the door hinge. (Fig. 4-6)

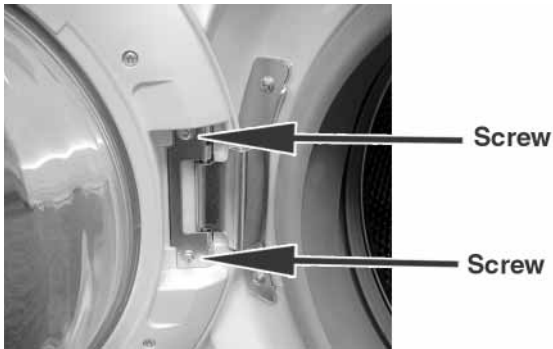

Fig. 4-6

panel. (See "Removing the Porthole Diaphragm" to remove the entire diaphragm.) The door switch is secured to the washer front panel with two, size 15 Torx screws. (Fig. 4-9) Once these screws are removed, the door switch will remain in place until it is lifted slightly and pulled back from the washer panel. Then, remove the wire plug from the door switch.

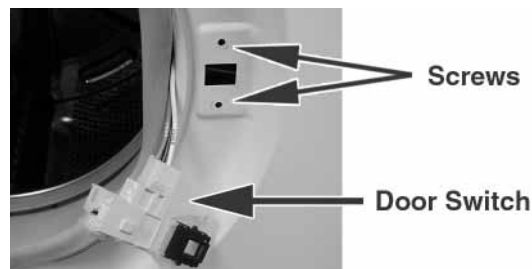

Fig. 4-9

Removing the Door Switch

If the top cannot be removed, access to the door switch requires that the porthole diaphragm be eased back from the front of the washer. To do this, locate the retainer spring and use a small tool to grab the hoop in the spring. (Fig. 4-7) Pull the retainer forward and then off the perimeter of the diaphragm.

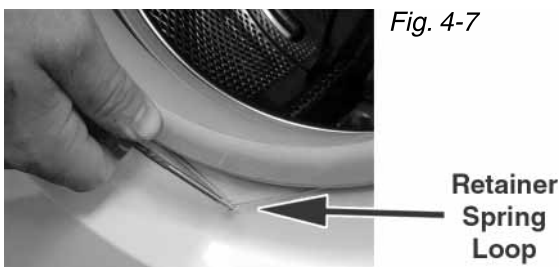

Fig. 4-7

Ease the edge of the diaphragm off of the lip of the washer front near the door switch. (Fig. 4-8) Remove enough of the diaphragm to gain access to the door switch behind the washer dryer front



Fig. 4-8

Removing the Porthole Diaphragm

The porthole diaphragm can be completely removed from the outer rim of the tub assembly. After removing the retainer (See Fig. 4-7), locate and loosen the 8mm bolt that holds the clamp to the drum. (Fig. 4-10) The diaphragm can now be removed from the tub. Pull the diaphragm off the drum and out of the machine.

Note: *The Heater Housing and Coil enter the boot at the 1 o'clock position. Use care not to damage the diaphragm.*

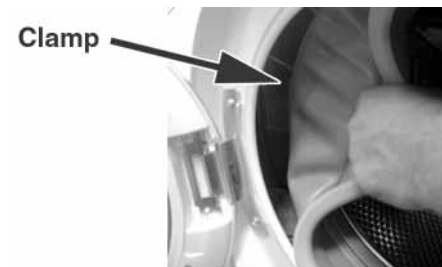

Fig. 4-10

Detergent Dispenser Assembly / Water Valves

Access to the Detergent Dispenser and Water Valves requires that the top of the washer be removed.

Removing the Dispenser Assembly

Begin by removing the top, then use two hands to pull the dispenser drawer completely out of the housing. (Below)



Remove the two Phillips Head screws securing the front of the detergent dispenser assembly to the top of the Control Panel. (Fig. 4-11) Remove the four screws securing the detergent dispenser assembly to the dispenser valves. (Fig. 4-12) Disconnect the two wires from the hot valve.



Fig. 4-11

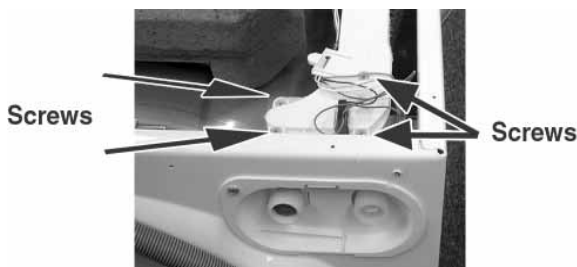

Fig. 4-12

Disconnect the dispenser hose from the detergent dispenser assembly by pulling the loop on the hose off to the side of the assembly. (Fig. 4-13) Once that is removed, the hose can be pulled straight off. Now you can lift the detergent dispenser assembly out.

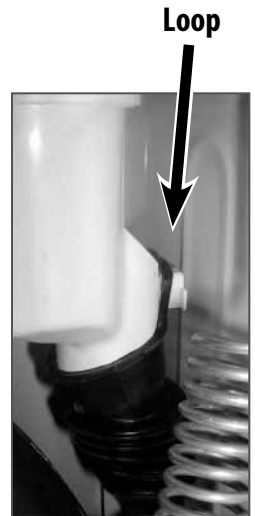

Fig. 4-13

IMPORTANT!

Be sure to reattach the hose correctly, or it will vibrate off of the bottom of the housing and the unit will leak water.

Removing the Water Valves

When the Detergent Dispenser Assembly is removed, the water valves will be exposed. Make sure the water valve seals are correctly installed on the water valves before re-assembly. (Fig. 4-14) Remove the two screws that secure the valves to the back of the machine. (Fig. 4-15, next page)

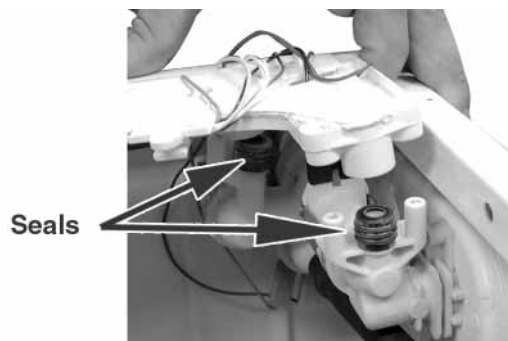

Fig. 4-14

IMPORTANT!

It's very important to note the orientation of the wiring on the valves for re-installation. If the wiring is switched the water temperatures will be incorrect, and on condenser machines, the dry cycle will not operate correctly.



Fig. 4-15

Pressure Switch

The Pressure Switch is located on the top-right, front corner of the machine. The pressure switch can be accessed once the top is removed.

Removing the Pressure Switch

Unclip the pressure switch from the cabinet. Keep the plastic bracket attached. (Fig. 4-16) Using pliers, squeeze the clamp to disconnect the black hose from the bottom of the pressure switch. (Fig. 4-17) Be careful not to pull up on the hose too much, or it may become disconnected from the bottom of the drum.

Next, squeeze the tabs (Fig. 4-17) to remove the wiring harness connectors from the pressure switch. Remove the plastic bracket that clips the pressure switch onto the cabinet, then reinstall it onto the replacement pressure switch. Be sure to check the wire connector for a tight connection after re-installation.

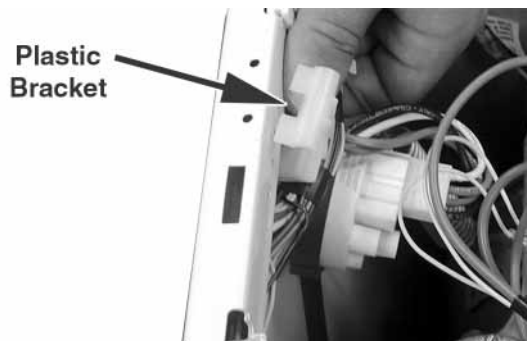

Fig. 4-16

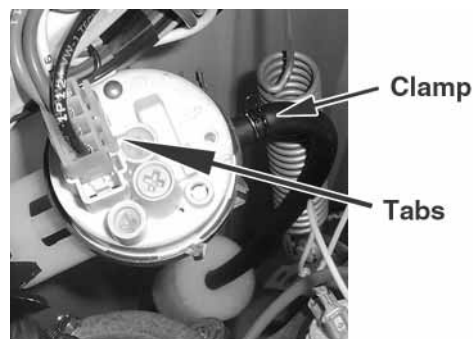

Fig. 4-17

Removing the Heater Coil and Housing

The heater housing and coil come as one assembly. You cannot remove the coil from the housing.

Carefully mark all the wires and remove them from the fan motor, ECO's, NTC sensor, and heater coil. Next, remove the two 13mm nuts that secure the heater housing bracket to the counterweight. (Fig. 4-20). Lift the duct straight up from the rear. Disconnect the porthole diaphragm where it attaches to the front of the heater housing using care not to damage the diaphragm.

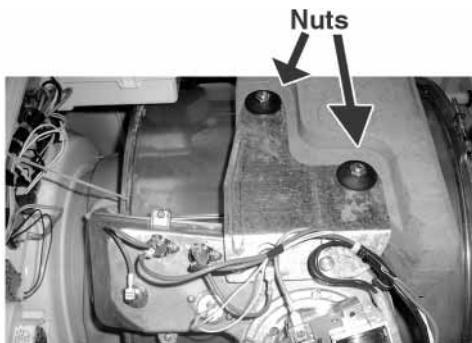
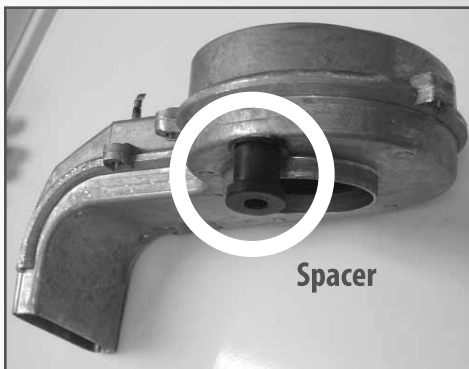

Fig. 4-20

IMPORTANT! About Vented Models



Vented models have a rubber spacer on the heater housing that assures clearance for adequate airflow to the fan. Check that this spacer is properly installed before reassembly.

IMPORTANT! About Condenser Models

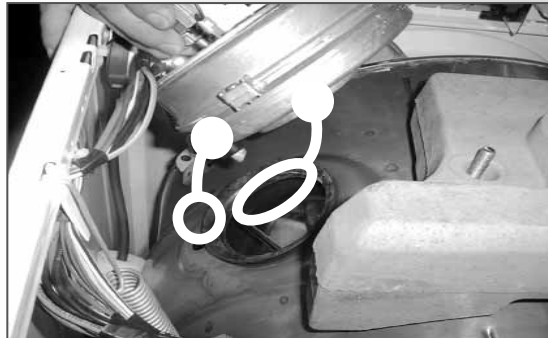

Fig. 4-21

There are two gaskets on the heater housing assembly. When reinstalling the assembly, you must align these two gaskets with the corresponding holes. (Fig. 4-21) After carefully aligning the gaskets with the holes, apply downward pressure as you tighten the two nuts that secure the heater housing bracket to the counterweight. (Fig. 4-22) If the gaskets are not seated correctly, the unit will leak.

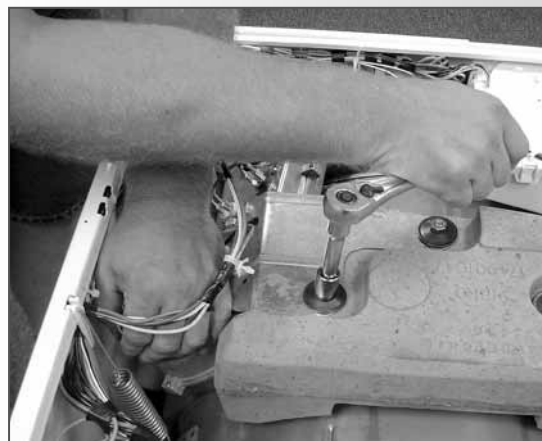

Fig. 4-22

Lower Panel / Drain Pump / Pump Filter

*The Drain Pump is located at the lower, right-corner of the machine.
You'll need to remove the Lower Panel to access the Drain Pump and Pump Filter.*

Removing the Lower Panel

Gently ease down the top of the panel with a flat blade screwdriver or plastic putty knife.

Remove the panel by lifting slightly and pulling forward.
(Below)

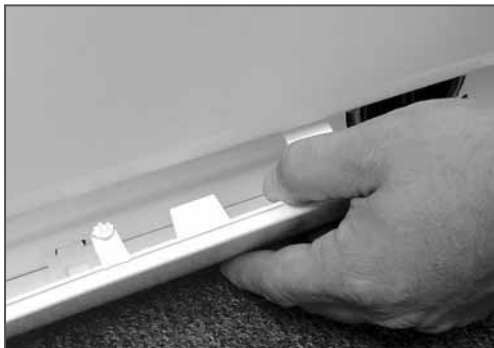
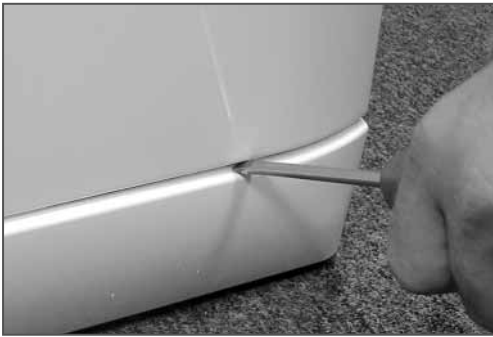

Removing the Drain Pump

With the Lower Panel removed and any residual water drained from the unit, gently tip the washer onto its' left side.

Remove the 4 screws that secure the sheet metal cover to the bottom of the washer. (Below) Remove the metal cover.

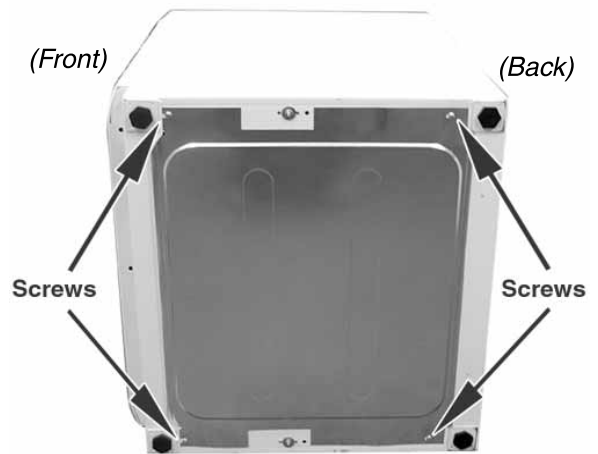

Remove the two screws that secure the pump to the cabinet. (Fig. 4-23) Rotate the pump clockwise from inside the unit and then pull to remove it from the cabinet.

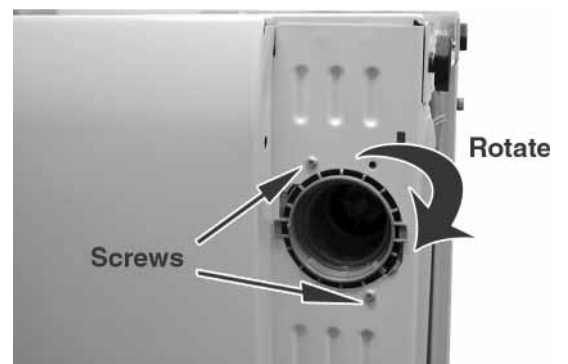

Fig. 4-23

(Continued on the next page)

Before you disconnect the hoses, note their orientation and place a towel under them to catch any water left inside. Unclamp the hoses from the drain pump and remove the pump assembly. (Fig. 4-24)

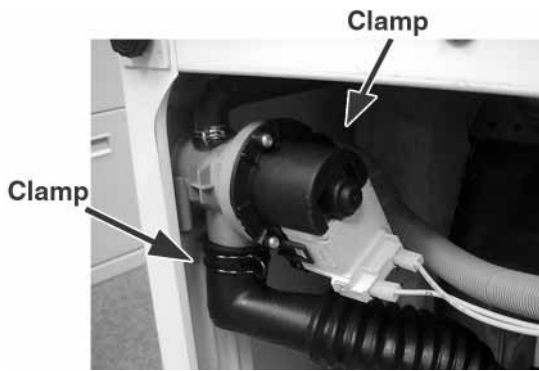

Fig. 4-24

To Clean Out the Large Item Filter

To clean out the Large Item Filter, turn the large knob counterclockwise and pull it out. (Below) Place a small pan or towel under the pump prior to removing the large item filter. There WILL be water in the pump housing.



Back Panel / Main Motor / Module Board

The Main Motor and Module Board can be accessed once the back panel has been removed.

Removing the Back Panel

Remove the 7 Phillips screws that secure the panel to the back of the cabinet. (Below) Now lift the panel off.

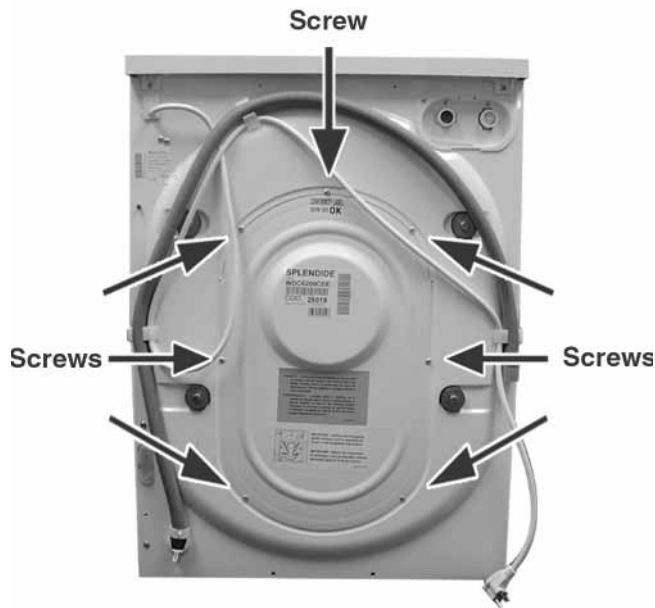

Removing the Main Motor

After removing the back panel, remove the Drive Belt. Next, remove the two 13mm mounting bolts that secure the motor to the tub. (Fig. 4-25) Slide the motor and bracket out 1 inch from the tub. Be-

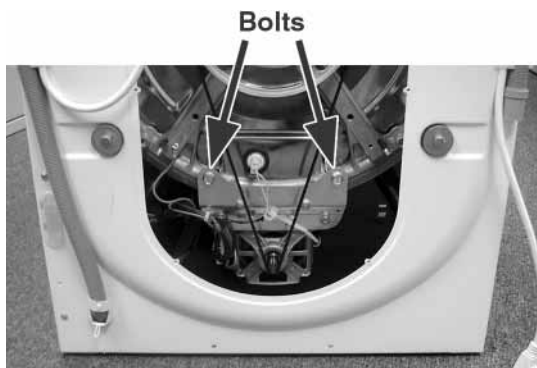

Fig. 4-25

fore completely removing the motor assembly, use needle-nose pliers to remove the two plastic wire ties from the bracket.

IMPORTANT!

When re-installing the Main Motor, it's very important to make sure that it's properly re-seated and aligned, with the rubber hanger on the right, rear-side of the motor. Check that the wire ties are also replaced.

Removing the Module Board

Remove the two, size 15 Torx Head screws that secure the Module Board to the case (below). To remove the board, swing the bottom of the board out of the unit, then the top of the board.

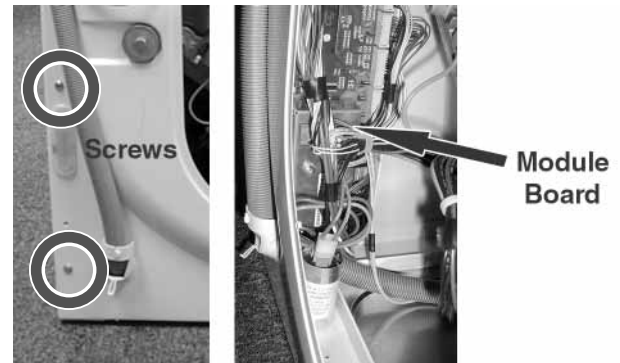

IMPORTANT!

When reinstalling the Module Board, do not confuse the CNI and CNF plug locations. (See "Connector Locations on the Module Board"). Also, pay close attention to the orientation of the CNG plug. Make sure that the pins are on the top of the CNG plug when the board is in the machine.

Shock Absorbers

The Shock Absorbers can be accessed once the bottom panel has been removed.

Removing the Bottom Panel

The tub is held in position by two shock absorbers. To access the Shock Absorbers, First, place the washer-dryer on its left side.

Remove the 4 screws that secure the sheet metal cover to the bottom of the washer. (Below) Now, remove the metal cover.

Removing the Shock Absorbers

Remove the bolts that secure the shock absorbers to the tub using a 12mm, 15mm or 13mm socket (depending on serial number).

Remove the bolts that secure the shock absorbers to the bottom of the case using a 15mm socket. (Fig. 4-26)

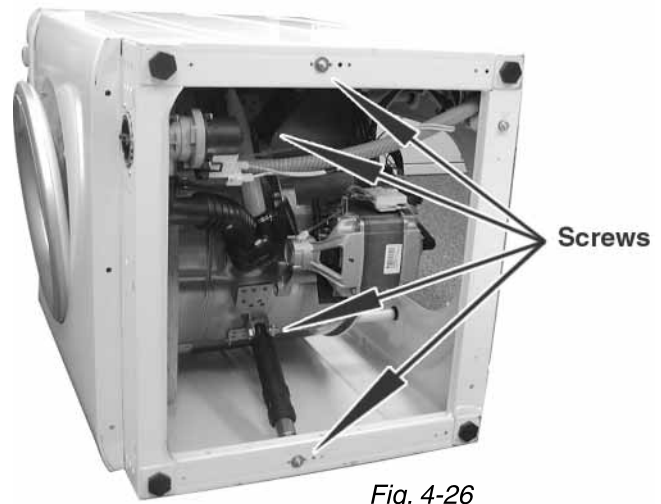
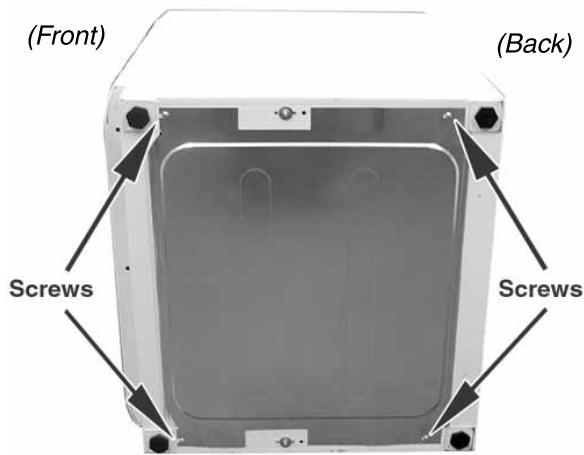

NOTES:

NOTES:

Component Testing Procedures

Connector Locations on the Module Board

The following tests are performed by taking ohm readings on the Module Board connections listed below. The Module Board can be accessed once the back panel has been removed. See "Component Access Locations."

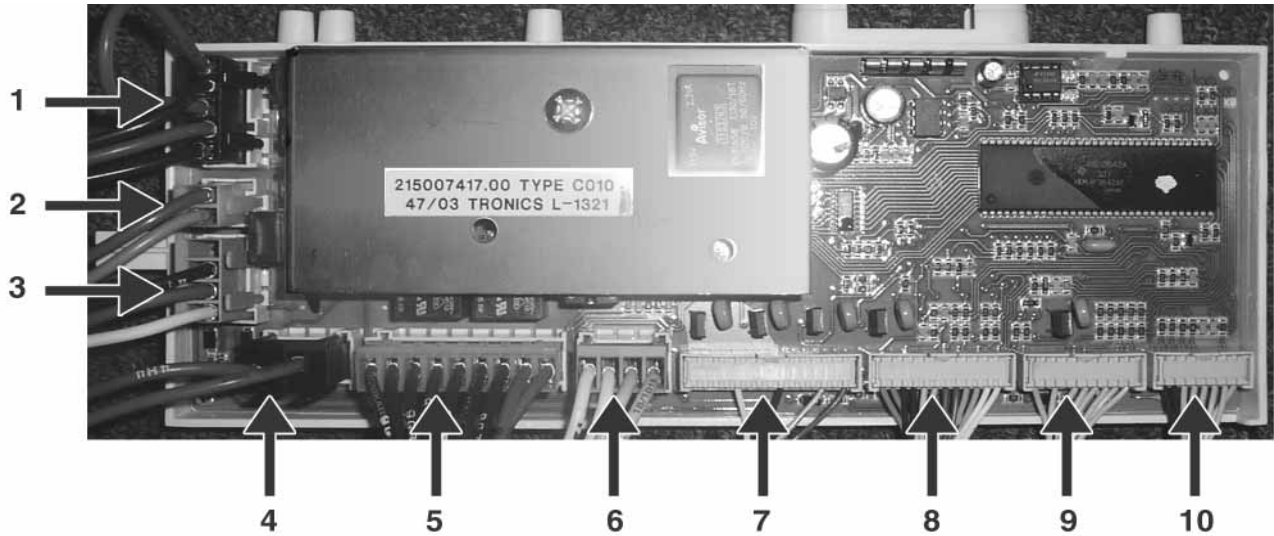

Component	Connector	Fault Code(s)*
1. Door Switch	CNJ	N/A
2. Power in from Surge Protector	CNK	N/A
3. Pressure Switch	CNI	F04, F05, F10, F14
4. Heating Element	CNH	F15
5. Main Motor	CNG	F01, F02
6. Pump / Fan Motor	CNF	F05, F11, F13
7. Water Valves	CNE	N/A
8. Push Buttons, Dry Time/Water Temp. Selectors	CNC	F08
9. Cycle Selector	CND	F06
10. NTC Sensors / LED's	CNB	F03, F13

* For more information about how to read Fault Codes and what they mean, see the "Fault Code Chart"

(Continued on the next page)

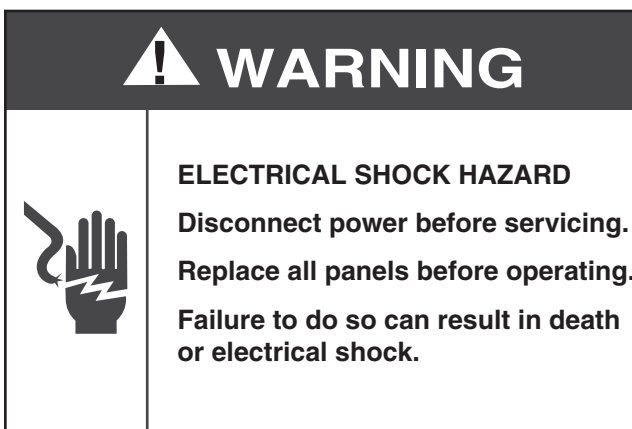

Introduction

Before testing the components, **ALWAYS**:

- Make sure that the power cord is firmly plugged into a live circuit with the proper voltage.
- Check for a blown household fuse or circuit breaker that has tripped.
- Make sure that the dryer vent is properly installed and clear of lint obstructions. (WD2100 and WD2000S Only.)

When testing, follow these instructions:

- Resistance tests **MUST** be made with the power cord unplugged from the outlet, and the wire connector removed from the Module Board.
- All tests should be made with a VOM (volt ohmmeter) or DVM (digital volt ohmmeter) having a sensitivity of 20,000 ohms-per-volt DC or greater.
- **BEFORE** replacing any component, **ALWAYS** check for wire connectors that are not pressed tightly into their terminals. Tests **MUST** be made with **ALL** connectors attached. Look for broken or loose wires, failed terminals, or wires that are not pressed into their connectors far enough.

Your Test Results

If the readings you obtain with the following tests match the specified range, the tested component is operating correctly.

If the readings you obtain are not in the specified range, call Splendide Service at 1-800-356-0766 (503-655-2563) ext. 5 for further assistance. **Have the Model and Serial Number of your machine ready when you call.**

1. Door Switch Testing

Door Switch Test Points are located on the CNJ connector on the Module Board (See "Connector Locations on the Module Board").

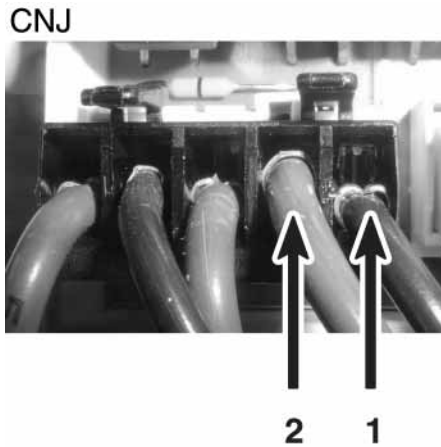

Fault Codes: N/A

To check the Door Switch for proper operation, the door must be locked:

1. Begin with the machine OFF. Using the Program Selector, select any cycle.
2. Next, press the ON/OFF button "in" to the ON position. You'll hear the door lock engage.
3. Now, unplug the washer-dryer from the wall outlet and check for continuity at the following points.

NOTE: Because the washer-dryer will automatically unlock, the reading must be taken within 1-minute after the washer-dryer is unplugged.

	Test Points	Reading
Unlocked Door	1 to 2	INFINITY (OL)
Locked Door	1 to 2	0 ohms

2. Power “in” from the Surge Protector Test

Surge Protector Test Points are located on both the Surge Protector and on the CNK Connector. The Surge protector is connected to the Module Board (See “Connector Locations on the Module Board”). The CNK Connector is on the Module Board (See “Connector Locations on the Module Board”).

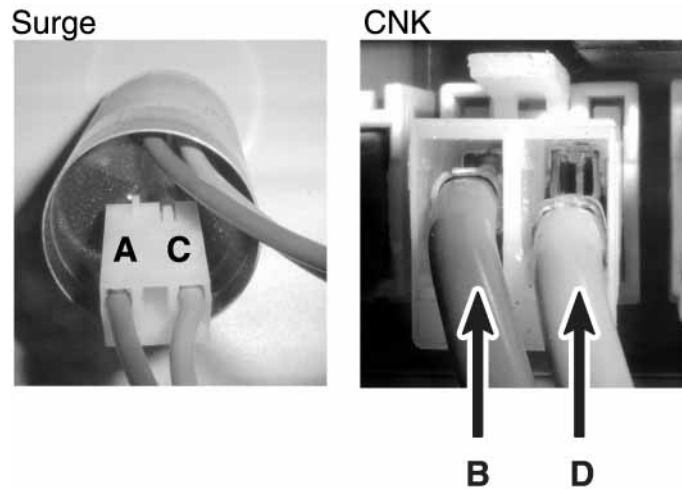

Fault Codes: N/A

	Test Points	Reading
Surge Protector to CNK	A to B	0 ohms
Surge Protector to CNK	C to D	1.0 ohms

3. Pressure Switch Test

Pressure Switch Test Points are located on both the CNI Connector and on the Pressure Switch. The CNI Connector is on the Module Board (See "Connector Locations on the Module Board"). The Pressure Switch can be accessed once the top is removed (See "Component Access Locations").

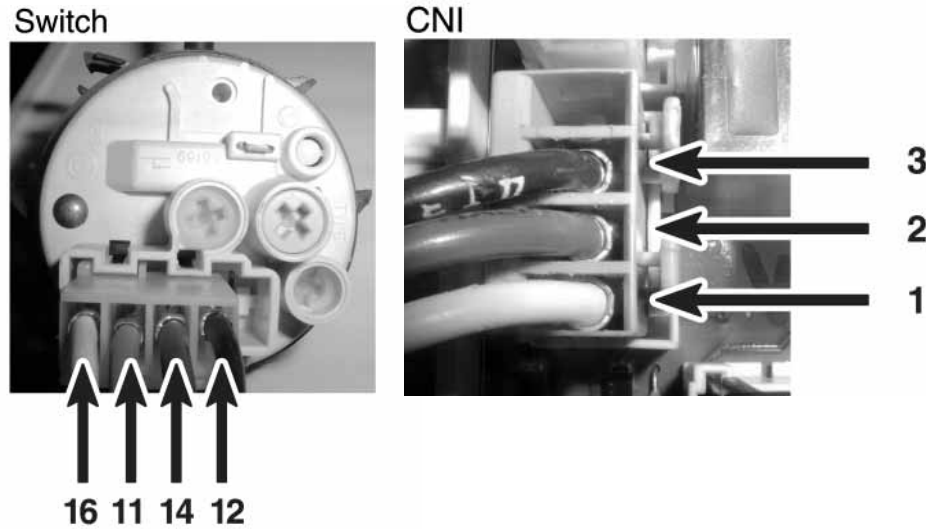

Fault Codes: F04, F05, F10, F14

	Test Points	Reading
Water Level Empty	11 to 12	0 ohms
Water Level Full	11 to 14	0 ohms
Water Level Overfull	11 to 16	0 ohms

	Test Points	Reading
CNI to Switch	1 to 16	0 ohms
CNI to Switch	2 to 14	0 ohms
CNI to Switch	3 to 12	0 ohms

4. Heating Element Test

Heating Element Test Points are located on the CNH Connector on the Module Board
(See "Connector Locations on the Module Board").

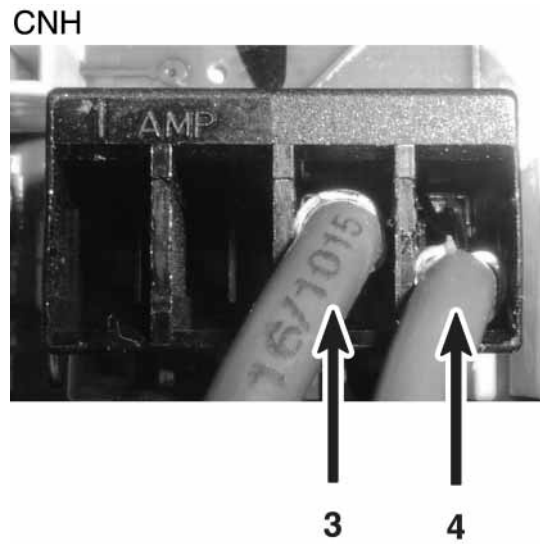

Fault Codes: F15

	Test Points	Reading
CNH Connector	3 to 4	11 ohms

5. Main Motor Test

Main Motor Test Points are located on the CNG Connector on the Module Board
(See "Connector Locations on the Module Board").

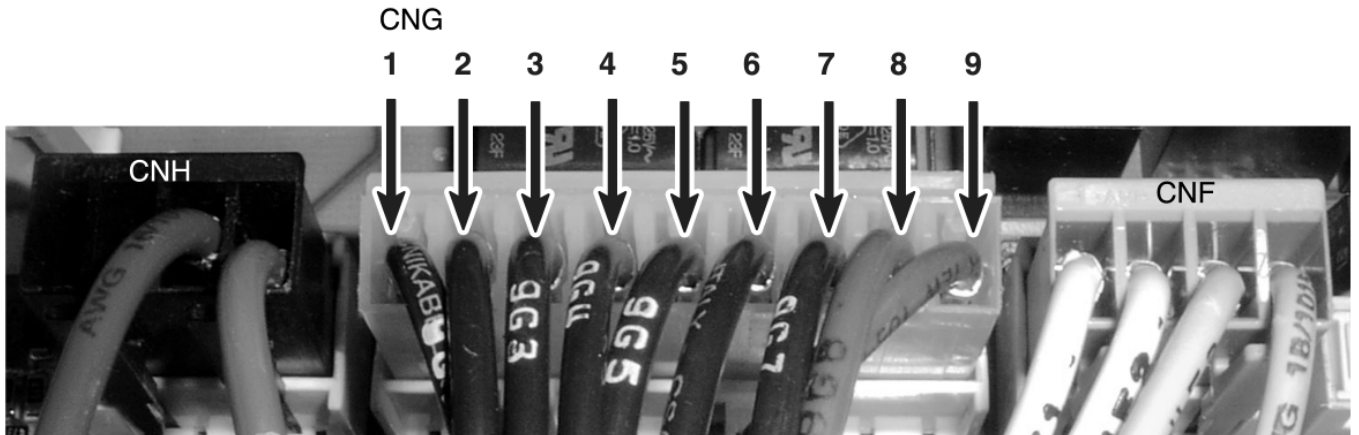

Fault Codes: F01, F02

	Test Points	Reading
Motor Protector	1 to 5	0 ohms
Stator Tap	2 to 4	0.6 ohms
Stator	2 to 3	1.2 ohms
Rotor	6 to 7	3.0 ohms
Tachometer	8 to 9	120 ohms

Running the Main Motor with AC Voltage Test:

1. Connect the AC Line Cord to Test Point 2 and Test Point 6
2. Jumper Test Points 7 to 3 for NORMAL Speed, or 7 to 4 for HIGH Speed. **DO NOT** run at HIGH Speed for more than 30 seconds.

6. Fan Motor / Water Pump Test

Fan Motor and Water Pump Test Points are located on the CNF connector on the Module Board (See "Connector Locations on the Module Board").

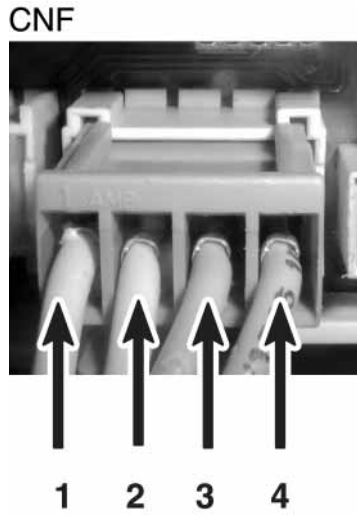

Fault Codes: F05, F11, F13

	Test Points	Reading
CNF Connector (Fan Motor)	1 to 2	7.5 ohms
CNF Connector (Water Pump)	3 to 4	22.5 ohms

7. Water Valve Test

Water Valve Test Points are located on the CNE Connector on the Module Board
(See "Connector Locations on the Module Board").

CNE

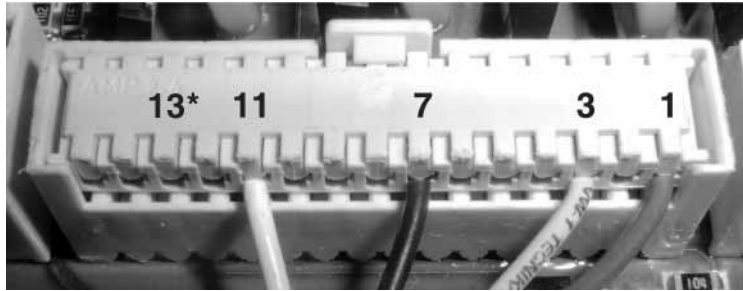

NOTE: Test Point '13' is for the Condenser Valve. The Condenser Valve is located on ventless (Comb-o-matic) units ONLY.

Fault Codes: N/A

	Test Points	Reading
Cold Valve	3 to 1	1000 ohms
Hot Valve	3 to 7	1000 ohms
Cold Softener	3 to 11	1000 ohms
Condenser Valve	3 to 13	1000 ohms

Model WD2000S (with serial number 406XXXXX and later)

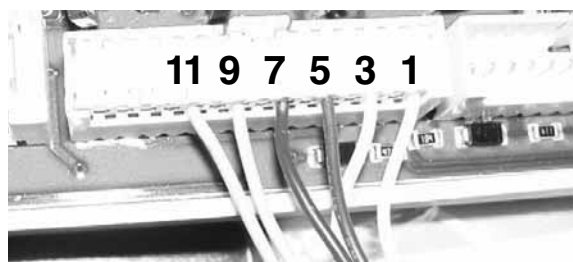

WD2000S (S/N 406XXXXX+)	Test Points	Reading
Cold Valve	3 to 1	1000 ohms
Hot Valve	5 to 7	1000 ohms
Cold Softener	9 to 11	1000 ohms

8. Push Buttons / Dry Time & Temp. Selectors

ON/OFF Button Test Points are on the ON/OFF Switch located behind the button. Push Buttons, Dry Time, and Water Temp. Selector Test Points are located on the CNC Connector on the Module Board (See "Connector Locations on the Module Board").

ON/OFF Switch

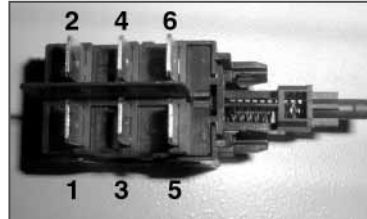

Fault Codes: F08="ON/OFF" Switch

ON/OFF Button	Test Points	Reading
ON/OFF Switch (Out)	1 to 3	INFINITY (OL)
ON/OFF Switch (Out)	1 to 5	INFINITY (OL)
ON/OFF Switch (Out)	3 to 5	0 ohms
ON/OFF Switch (Out)	2 to 4	INFINITY (OL)
ON/OFF Switch (Out)	2 to 6	INFINITY (OL)
ON/OFF Switch (Out)	4 to 6	0 ohms
ON/OFF Switch (In)	1 to 3	0 ohms
ON/OFF Switch (In)	1 to 5	INFINITY (OL)
ON/OFF Switch (In)	3 to 5	INFINITY (OL)
ON/OFF Switch (In)	2 to 4	0 ohms
ON/OFF Switch (In)	2 to 6	INFINITY (OL)
ON/OFF Switch (In)	4 to 6	INFINITY (OL)

CNC

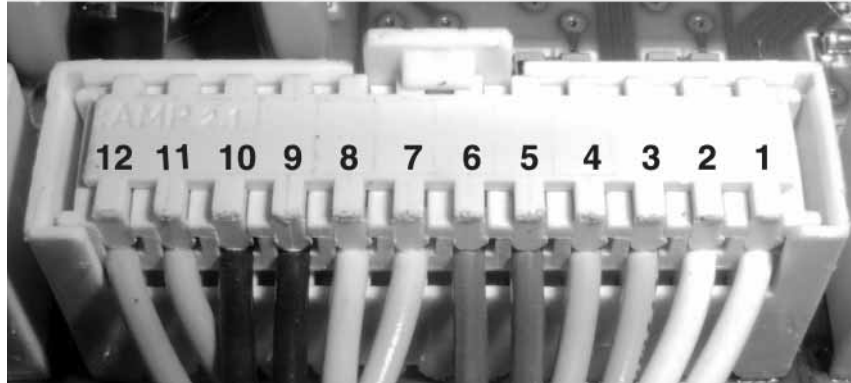

Push Buttons

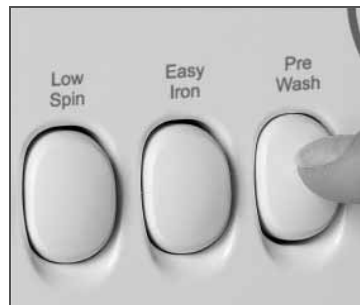

Option Buttons	Test Points	Reading
Pre-Wash (In)	1 to 2	0 ohms
Easy Iron (In)	3 to 4	0 ohms
Low Spin (In)	5 to 6	0 ohms
Extra Rinse (In)	7 to 8	0 ohms

(Continued on the next page)

Dry Time Selector



Wash Temp Selector



Dry Time Selector	Test Points	Reading
0 min.	9 to 10	4.6K ohms
30 min.	9 to 10	2.5K ohms
50 min.	9 to 10	919 ohms
70 min.	9 to 10	0 ohms
90 min.	9 to 10	INFINITY (OL)
100 min.	9 to 10	50.2K ohms
110 min.	9 to 10	12.94K ohms
120 min.	9 to 10	8.02K ohms

Water Temp. Selector	Test Points	Reading
Hot	11 to 12	4.6 K ohms
Warm	11 to 12	INFINITY (OL)
Cold	11 to 12	8.02K ohms

9. Cycle Selector Test

Cycle Selector Test Points are located on the CND Connector and on the Cycle Selector. The CND Connector is located on the Module Board (See "Connector Locations on the Module Board"). The Cycle Selector can be accessed once the washer-dryer top is removed (See "Component Access Locations").

CND

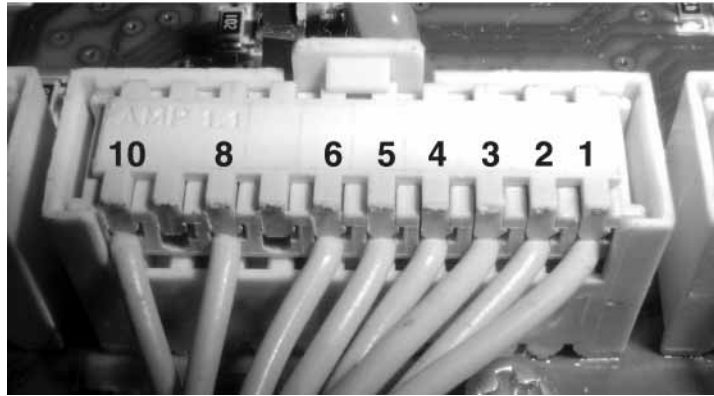

Selector (Close Up)



Selector

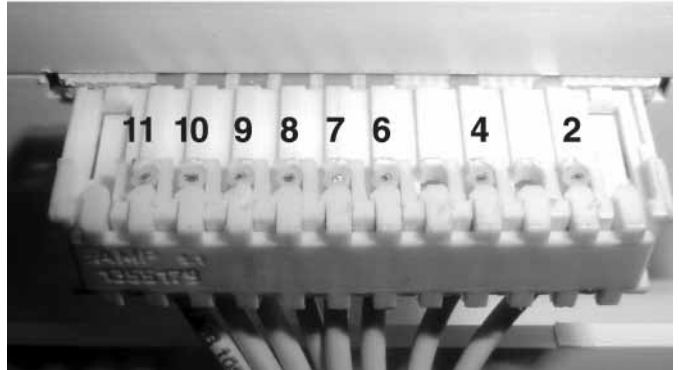

Fault Codes: F06

	Test Points	Reading
CND to Selector	1 to 11	0 ohms
CND to Selector	2 to 10	0 ohms
CND to Selector	3 to 9	0 ohms
CND to Selector	4 to 8	0 ohms
CND to Selector	5 to 7	0 ohms
CND to Selector	6 to 6	0 ohms
CND to Selector	8 to 4	0 ohms
CND to Selector	10 to 2	0 ohms

10. NTC Sensors / LED Tests

NTC Sensor and LED Test Points are located on the CNB Connector and on the LED's. The CNB Connector is on the Module Board (See "Connector Locations on the Module Board"). The LED's can be accessed once the washer-dryer top is removed (See "Component Access Locations").

CNB

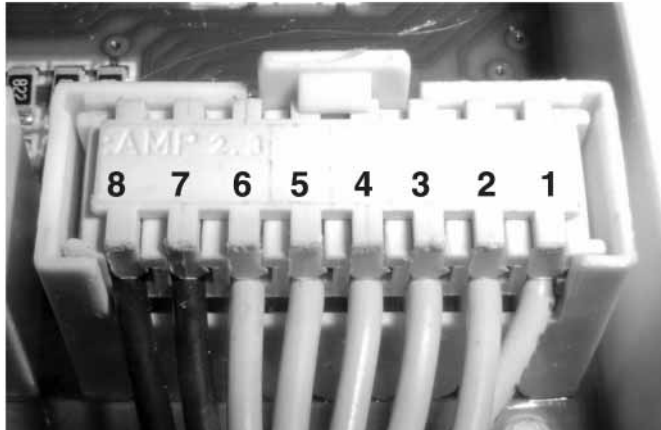

LED's

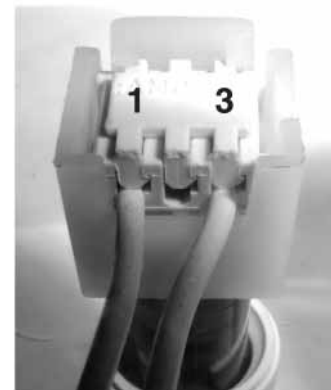

NOTE: NTC's (Negative Temperature Coefficients) vary resistance with temperature. The higher the temperature, the lower the resistance.

Fault Codes: F03 = Wash NTC, F13=Dry NTC

CNB to CNB	Test Points	Reading
Wash NTC	1 to 2	20K ohms@70°F
Dry NTC	3 to 4	20K ohms@70°F

CNB to LED's	Test Points	Reading
Status/Door Lock LED	5 to 3	0 ohms
Status/Door Lock LED	6 to 1	0 ohms
Auto Dry LED	7 to 3	0 ohms
Auto Dry LED	8 to 1	0 ohms

Diagnosis & Troubleshooting

Introduction

This section includes an Explanation of the Fault Codes for models WD2100, WD2000S, WDC6200CEE and WDC5200 as well as a Fault Code/Testing Procedure Chart and a Problem/Testing Procedure Chart. Time-saving Tech Tips are included at the end of the chapter. **Contact Westland Sales for a complete list of Service Bulletins and updates for these models.**

Explanation of Fault Codes

These appliances incorporate an onboard diagnostic system to help you troubleshoot any problems that you may encounter. (See Chart on next page.)

When the machine is in the Fault Mode,

- The program selector will spin around continuously while the code is displayed through a series of flashes from the "Status/Door Lock" LED.
- The "Status/Door Lock" light will flash 1-15 times, pause for 10 seconds, and then repeat the same number of flashes.

Example

If the Status/Door Lock light,

- Flashes 3-times
- Pauses for 10 seconds
- Then, flashes 3 times

The machine is displaying an "F03" Fault Code.

Fault Code / Testing Procedure Chart

See "Explanation of the Fault Codes" on the previous page to determine the Fault Code that the washer-dryer is displaying. Then, follow the recommended testing procedure to troubleshoot the problem. Call Westland Sales if the machine continues displaying the Fault Code.

Fault Code	Explanation / Recommended Testing Procedure
F01	Short-circuited Motor TRIAC on Module Board <ul style="list-style-type: none"> • Verify Drive Motor connections and wiring. See "Component Testing". • Open the door of the washer-dryer and verify the drum spins freely and is not hitting anything.
F02	Blocked Motor/Tachometer Open/Short-Circuited <ul style="list-style-type: none"> • Verify Drive Motor connections and wiring. See "Component Testing". • Verify motor operation. Refer to "Test Running the Main Motor with AC Voltage" pg 47. • Open the door of the washer-dryer and verify the drum spins freely and is not hitting anything.
F03	Wash NTC Sensor Open/Short-Circuit <ul style="list-style-type: none"> • Verify NTC Connections and wiring. See "Component Testing".
F04	Both Empty and Over Flow Signals Present <ul style="list-style-type: none"> • Verify Pressure Switch connections and wiring. See "Component Testing".
F05	Blocked Pump/Pressure Switch Stuck on Empty <ul style="list-style-type: none"> • Check Pump Pre-Chamber for blockage. See "Component Access". • Verify pump connector and wiring. See "Component Testing". • Verify Pressure Switch connections and wiring. See "Component Testing".
F06	Selector Binary Code Not Found <ul style="list-style-type: none"> • Verify Program Selector connections and wiring. See "Component Testing".
F07	<i>Not Applicable</i>
F08	Missing or Incorrect ON/OFF Switch Signal <ul style="list-style-type: none"> • Verify ON/OFF Switch connections and wiring. See "Component Testing".

Fault Code	Explanation / Recommended Testing Procedure
F09	File Set-Up Error (Unverifiable Fault)
F10	Missing or Conflicting Pressure Switch Signal • Verify Pressure Switch connections and wiring. See "Component Testing".
F11	Drain Pump Power Supply Failure • Verify Drain Pump connections and wiring, See "Component Testing".
F12	Communication Failure • Verify Module Board connections and wiring. See "Component Testing".
F13	Dry NTC Sensor Open/Shorted Circuit • Verify NTC Sensor connections and wiring. See "Component Testing". • Verify the fan motor is not stuck, obstructed, or open. See "Component Access".
F14	Dryer Element on, Pressure Switch Sensing Water in Drum • Verify pressure switch connector and wiring. See "Component Testing".
F15	Dry Heating Element Relay Malfunction • Verify Heating Element connections and wiring. See "Component Testing".

Problem / Testing Procedure Chart

Follow these steps in the order they are listed to effectively troubleshoot the problem.
Call Westland Sales if the problem continues after you have completed the recommended tests.

Problem	Testing Procedure
WON'T POWER UP	<ol style="list-style-type: none"> 1. Check the line voltage for blown fuses. 2. Check for voltage going to the Module Board. 3. Before continuing, unplug the unit. 4. Check continuity of line cord and line filter. 5. Remove the washer-dryer back and check wire harness connections to the Module Board. 6. Check for correct wiring at the surge protector.
WON'T START CYCLE	<ol style="list-style-type: none"> 1. Open and close the door. 2. Verify there is water entering the Hot and Cold Valves. 3. Check the Door Switch using the Component Testing procedure. 4. If door is locked, select "Drain" on the Cycle Selector to drain the drum. 5. Remove the washer-dryer top and check the wire harness connections.
WON'T DISPENSE LAUNDRY AIDS	<ol style="list-style-type: none"> 1. Verify the unit is level. 2. Verify the Dispenser Drawer is not clogged with detergent. 3. Check water connections to the unit. Check for plugged water valve screen. 4. Remove the top and check water connections within the unit.
WON'T FILL	<ol style="list-style-type: none"> 1. Check installation. 2. Check inlet valves. 3. Check water connections to the unit. Check for plugged water valve screen. 4. Remove the top and check water connections within the unit.
CYCLE SELECTOR ROTATES ON IT'S OWN	<ol style="list-style-type: none"> 1. Move the Cycle Selector knob to any position except a 'Reset' and the washer will return to the original cycle. 2. Check to see if the unit is displaying Fault Code (See "Explanation of the Fault Codes")
OVERFILLS	<ol style="list-style-type: none"> 1. Verify the unit is level. 2. Check Pump Drain system - this could indicate a failure to drain. 3. Check Operating Pressure Switch. 4. Check Pressure Switch hose for holes, cut marks. 6. Check the Module Board.

Problem	Possible Cause / Recommended Testing
DRUM WON'T ROTATE	<ol style="list-style-type: none"> 1. Remove the washer-dryer back and check the Drive Belt. 2. Check the Main Motor. 3. Check the Wire Harness connections.
WON'T DRAIN	<ol style="list-style-type: none"> 1. Remove the washer-dryer back and check the Drain Pump 2. Check that the Drain Hose and Large Item Filter is clear of foreign objects. 3. Check the Module Board.
MACHINE VIBRATES	<ol style="list-style-type: none"> 1. Verify the Transit Screws/Spacers have been removed. 2. Check the Installation. 3. Check the Leveling Feet. 4. Check for a weak floor. DO NOT install on carpet. <p>NOTE: Some vibration is normal.</p>
INCORRECT WATER TEMPERATURE	<ol style="list-style-type: none"> 1. Check that the Inlet Hoses are connected properly. 2. Remove the washer-dryer top and check the wiring to the Dry Time and Water Temperature Selectors to make sure they aren't reversed.
WON'T DRY	<ol style="list-style-type: none"> 1. Check the dry cycle and load size. If testing with the drum empty, use Permanent Press Dry or Delicates Dry ONLY. If testing with laundry in the drum, verify that the load weighs at least 2.2 lbs. when using the Cotton Heavy Duty Dry cycle. 2. Remove the washer-dryer top and check the ECO's. 3. Verify that the Fan Motor is rotating. If it is, go to Step 4. If not, try rotating it by hand. If you can't rotate it by hand, check for 110V AC across the two wires. If voltage is present, but the fan will not rotate, the Fan Motor will need to be replaced. 4. Perform a "Dryer Airflow and Heat Test" (See pg. 60)

Tech Tips

Manually Unlocking the Door

1. Unplug the power cord from the outlet and wait 10 min.
2. Remove the washer-dryer top.
3. Reach down along the inside of the front panel and locate the door latch assembly. Located on the side of the door latch assembly is a small black cylinder shaped tab (Right).
5. Use a small screwdriver to gently push the tab toward the front of the cabinet until you hear a click. Now, you can open the door.*

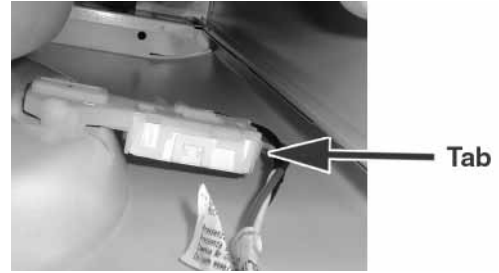

Opening Door with Broken Handle

1. Unplug the power cord from the outlet and wait 10 min.
2. Gently wedge the end of a Flat Head screwdriver into the gap between the broken piece of the handle and the door hook.
3. Next, while pushing towards the door, pull the screwdriver handle to the right.
4. Then, pull the screwdriver towards you while holding the door handle to the right to open the door.



***NOTE:** If you still cannot open the door, contact Splendide Technical assistance.

Performing a Dryer Airflow & Heat Test

1. Open the door.
2. Set the Cycle Selector to any 'DRY' cycle.
3. Set the Dry Time knob to '30' minutes.
4. Push the 'ON/OFF' button IN.
5. Once the Status/Door Lock LED lights SOLID, activate the Door Switch by inserting a screwdriver tip about 1/4" into the door hook entry hole.
6. Using the screwdriver, move the white-colored slide mechanism to the Right until it stops. HOLD the mechanism in place until the dryer turns on. (Approx. 10 seconds)
7. Place your hand on the Porthole Diaphragm at the 1 o'clock position to feel for heat and airflow. The airflow should be similar to a hand-held hair dryer on LOW and it should start heating up within 20 seconds. *NOTE: If either the heat or airflow are not present, see "Problem/Testing Procedure Chart" for further troubleshooting help.*
8. Release the Door Switch by advancing the Cycle Selector to a 'Reset' position. Once the Status/Door Lock LED blinks SLOWLY, use the screwdriver to push the white-colored slide mechanism to the

Right. It should spring back to the Left. *If you test a model WD2100 or WD2000S* and the Airflow and Heat Test results are normal but the problem persists, check the dryer exhaust system for obstructions:

- With the dryer ON, check the airflow exiting from the vent located on the outside wall and clear any obstructions.
- Disconnect the flex/metal dryer ducting from the back of the machine. With the dryer ON, check the airflow exiting from the back of the machine and clear any obstructions.

Winterization Instructions

To winterize your washer-dryer:

1. With the machine power OFF, pour ½ quart of RV-type antifreeze into the washer drum
2. Close the door. Advance the Program Selector knob to a SPIN position
3. Press ON/OFF Button (IN). Wait 1-2 minutes
4. Press ON/OFF Button (OUT). Unplug the washer-dryer from the electrical outlet (or disconnect power)
5. Turn the water supply faucets OFF. Disconnect the inlet hoses from the faucets. Drain any remaining water from the hoses. *Finished!*

Optional RV Winterization - If you're currently pumping antifreeze through the fresh water system, follow these steps to winterize:

1. With the machine power OFF, turn the WASH TEMP knob to HOT
2. Advance the Program Selector knob to REGULAR in Cotton Heavy Duty
3. Press the ON/OFF button (IN) and let the machine fill until antifreeze is in the drum
4. Advance Program Selector to a RESET. Wait 5 seconds (Status/Door Lock LED will blink)
5. Advance Program Selector to a SPIN position. Let the antifreeze drain from the drum
6. Advance Program Selector to RESET. Wait 5 seconds (Status/Door Lock LED will blink)
7. Turn the WASH TEMP knob to COLD
8. Advance the Program Selector knob to REGULAR in Cotton Heavy Duty
9. Let the machine fill until you see antifreeze in the drum
10. Advance the Program Selector knob to RESET. Wait 5 seconds (Status/Door Lock LED will blink)
11. Advance the Program Selector knob to SPIN. Let the antifreeze drain from the drum
12. Press the ON/OFF button (OUT). *Finished!*

To use again, flush the water pipes, then:

1. Reconnect the water inlet hoses to the corresponding HOT/COLD faucets. Turn the faucets ON. (NOTE: Check the water inlet hoses and pump periodically. Refer to the "Use & Care Guide" that came with the machine)
2. Plug the washer-dryer into an appropriate electrical outlet (or reconnect power supply)
3. With the ON/OFF button in the off (OUT) position, pour 1/2 TBSP. of powder detergent (or liquid equiv.) into the 'Detergent' compartment inside the Dispenser Drawer
4. Advance the Program Selector knob to an EXPRESS cycle
5. Press the ON/OFF button (IN) and allow the machine to run through the complete cycle to clean out any remaining antifreeze. *Finished!*

Verifying Normal Operation

Follow these steps in the order they are listed to test the washer-dryer for normal operation.

We recommend that you ALWAYS perform this test as the last step of your repair. It takes approximately 8 min. to complete.

Introduction

The following instructions explain how to test the washer-dryer to make sure everything's working properly. Keep in mind, this appliance operates differently than some of the previous Splendide models you may be familiar with.

It's important to note the following differences:

- The timer WILL NOT advance like a traditional, mechanical timer. It only sends a signal to the control board.
- All of the timing is controlled by a microprocessor on the board, so the Dry Time knob WILL NOT move, or "count down" the time.
- If you try to advance the Program Selector WITHOUT properly

resetting the machine by choosing a Reset position, the Program Selector will automatically advance to the original setting.

- To be sure that the machine is properly reset, it's a good idea to leave the power ON so you can monitor the Status/Door Lock LED. This LED will flash RAPIDLY when the selector is in a 'Reset' position. *NOTE: If the LED stays solid, the machine has not reset.*

Before beginning the test, remove all items from the drum, close the door, and press the ON/OFF button (in). Next, Reset the washer-dryer. To do this, advance the Cycle Selector to a 'Reset' position and wait 10 seconds.

You Select	Correct Washer-Dryer Response	Components Checked
1. "30" on Dry Time knob	After 5 seconds, Auto Dry LED turns ON. 'Status/Door Lock' LED flashes RAPIDLY, then SLOWLY.	LED'S, Door Lock System.
2. 'Super' wash cycle	Fill by water inlet valves. Two-way basket rotation.	Inlet Valves, Dispenser, Main Motor.
3. Any 'Reset'	After 5 seconds, 'Status/Door Lock' LED flashes QUICKLY.	
4. Any 'Spin'	Drain Pump turns ON. Basket rotates and ramps up.	Drain Pump, Main Motor.
5. Any 'Reset'	After 5 seconds, 'Status/Door Lock' LED flashes QUICKLY.	
6. Any 'Dry'	Fan turns ON. Two-way basket rotation.	Fan Motor
7. Any 'Reset'	After 5 seconds, 'Status/Door Lock' LED flashes QUICKLY.	
8. "0" on Dry Time knob	'Auto Dry' LED turns OFF. Wait 1-2 minutes. 'Status/Door Lock' LED flashes QUICKLY, then SLOWLY when the door unlocks.	LED's, Door Lock System.
9. ON/OFF (out)	'Status/Door Lock' LED turns OFF.	

-- End --

Wiring Diagrams

WD2100 / WD2000S

Splendide 2100 / Splendide 2000S Front-Loading Automatic Washer-Dryer with Vented Drying System

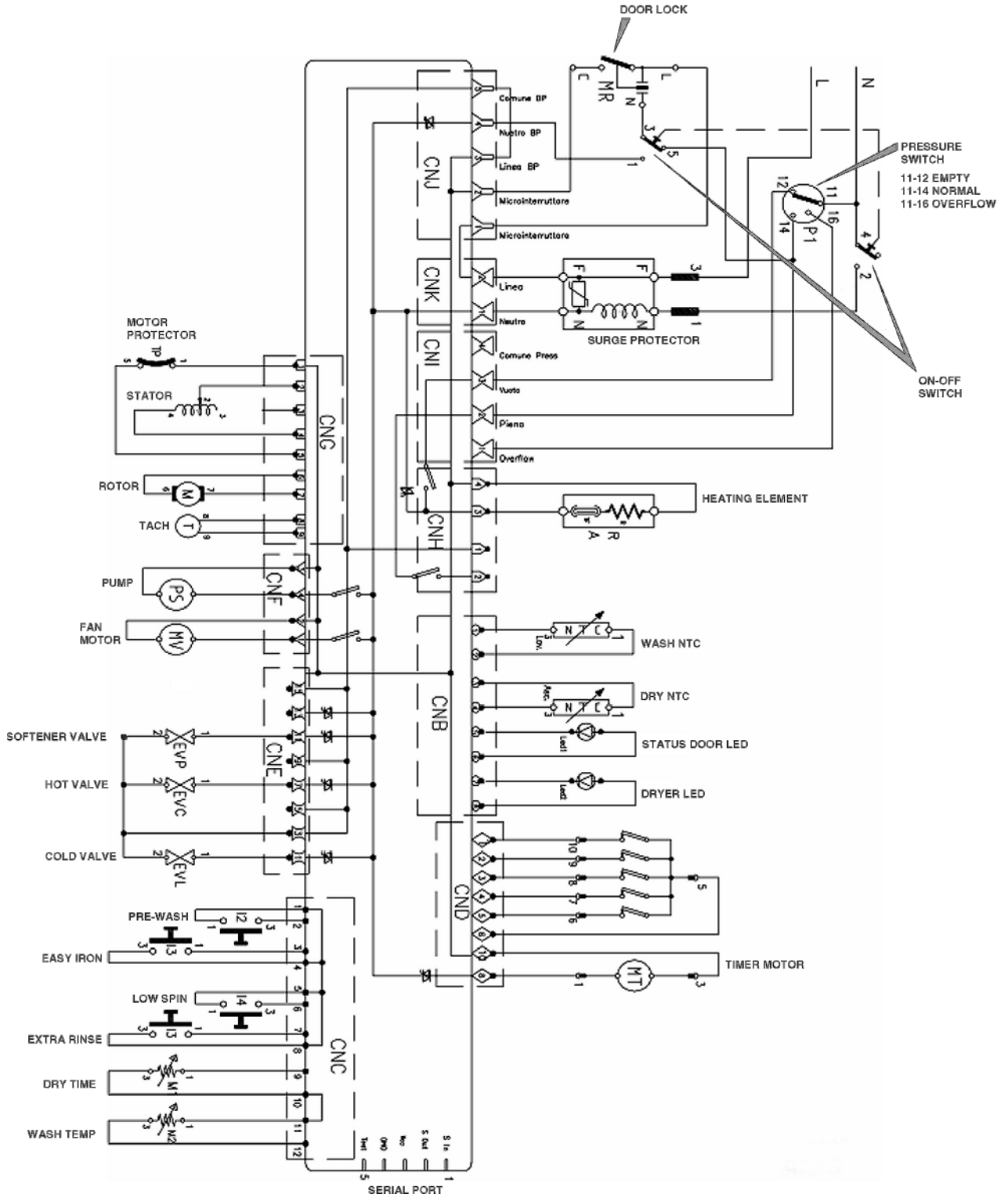

WDC6200CEE / WDC5200

Comb-o-matic 6200 / Comb-o-matic 5200 Front-Loading Automatic Washer-Dryer with Condenser (Ventless) Drying System

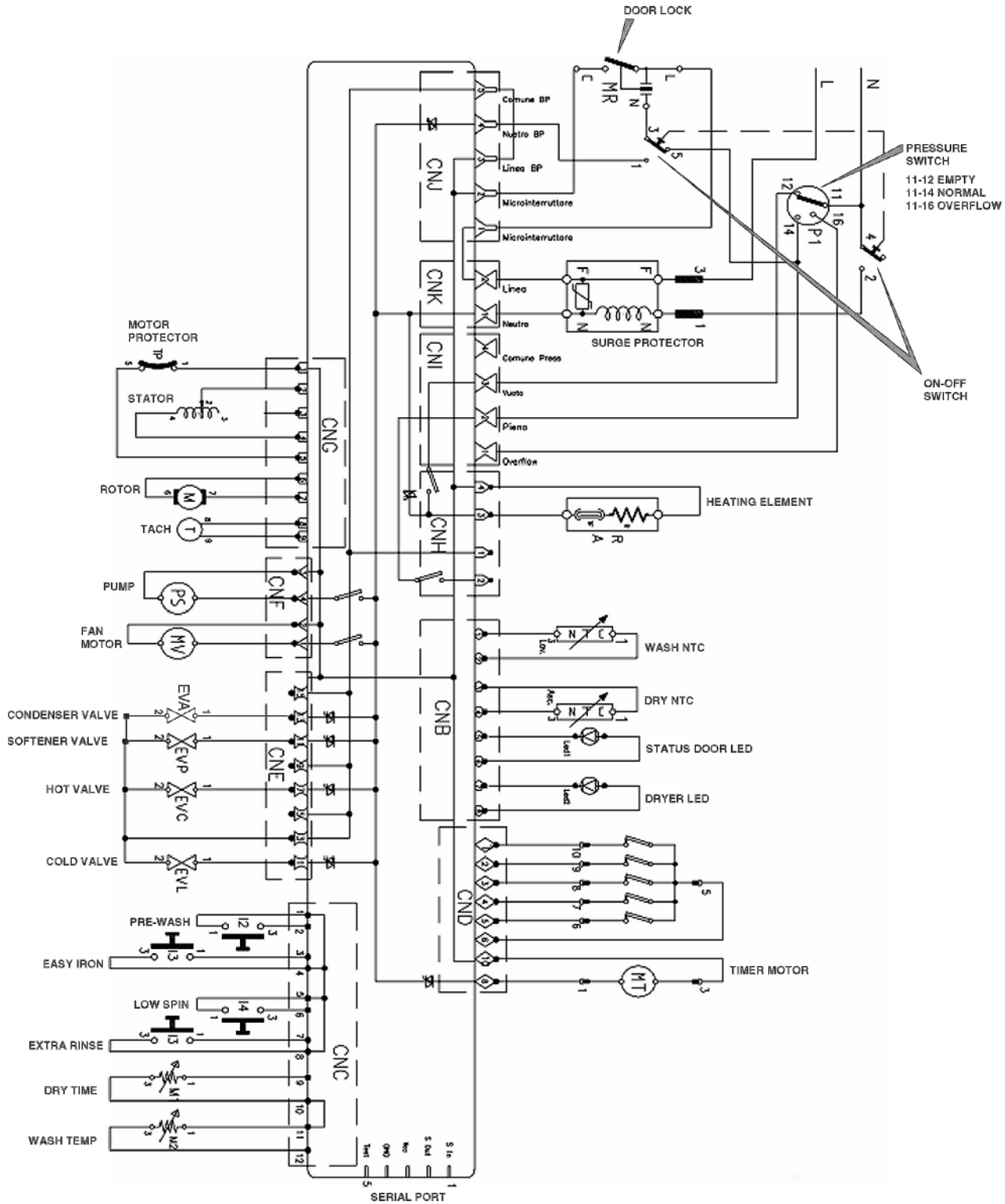

NOTES:



Splendide®

© Copyright 2004, Westland Sales, Clackamas, OR 97015