

PARTS MANUAL

450_{SERIES}



AHE-450-DE4

AHE-450-DW3



Heater Overview

- General ----- 5
- Top ----- 6
- Front ----- 7
- Sensors ----- 14
- A.C. Electric Element Components ----- 16
- Mixer Valve Assembly ----- 17
- Combustion Chamber Assembly ----- 20

Diesel-Burner

- Overview ----- 21

Miscellaneous Parts & Materials ----- 25

- Tools ----- 26

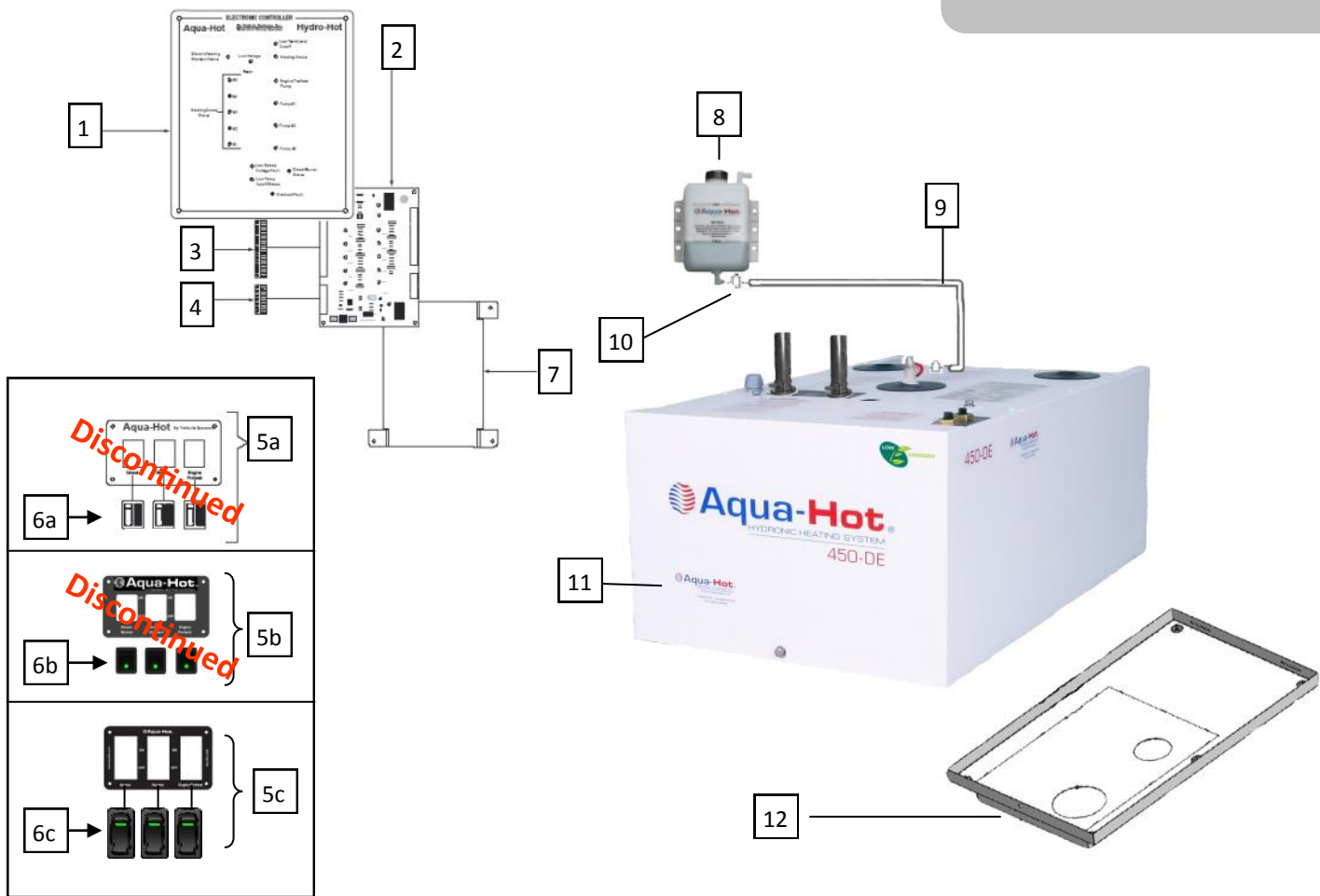

Key	Part Number	Date of Use	Description
1	SME-200-501		Faceplate, Electronic Controller, Assembly
2	ELE-PC4-010-AA		Controller, Electronic, 12 VDC
3	ELX-312-491		Plug, Electronic Controller, 20-Position
4	ELX-312-499		Plug, Electronic Controller, 8-Position
5a	ELE-000-507	04/2010 - 12/2010	Panel, Switch, Assembly, 12 VDC - OBSOLETE
5b	ELE-000-507	01/2011 - 08/2011	Panel, Switch, Assembly, 12 VDC - OBSOLETE
5c	ELE-000-509	09/2011 - Current	Panel, Switch, Assembly, 12 VDC
6a	ELX-283-284	04/2010 - 12/2010	Switch, Rocker, w/LED - OBSOLETE
6b	ELX-283-284	01/2011 - 08/2011	Switch, Rocker, w/LED - OBSOLETE
6c	ELX-283-283	09/2011 - Current	Switch, Rocker, w/LED
7	SME-EN4-008		Back, Electronic Controller, Enclosure
8	PLE-070-401		Tank, 3 QT, Expansion Assembly
9	PLE-210-191		Tube, Over Flow, Clear 5/8 in. x 8 ft.
10	PLX-CTB-250		Clamp, Hose, Constant Tension, 23/32 in.
11	SME-450-030		Cover, Access, Main
12	SME-450-070		Tray, Mounting Assembly

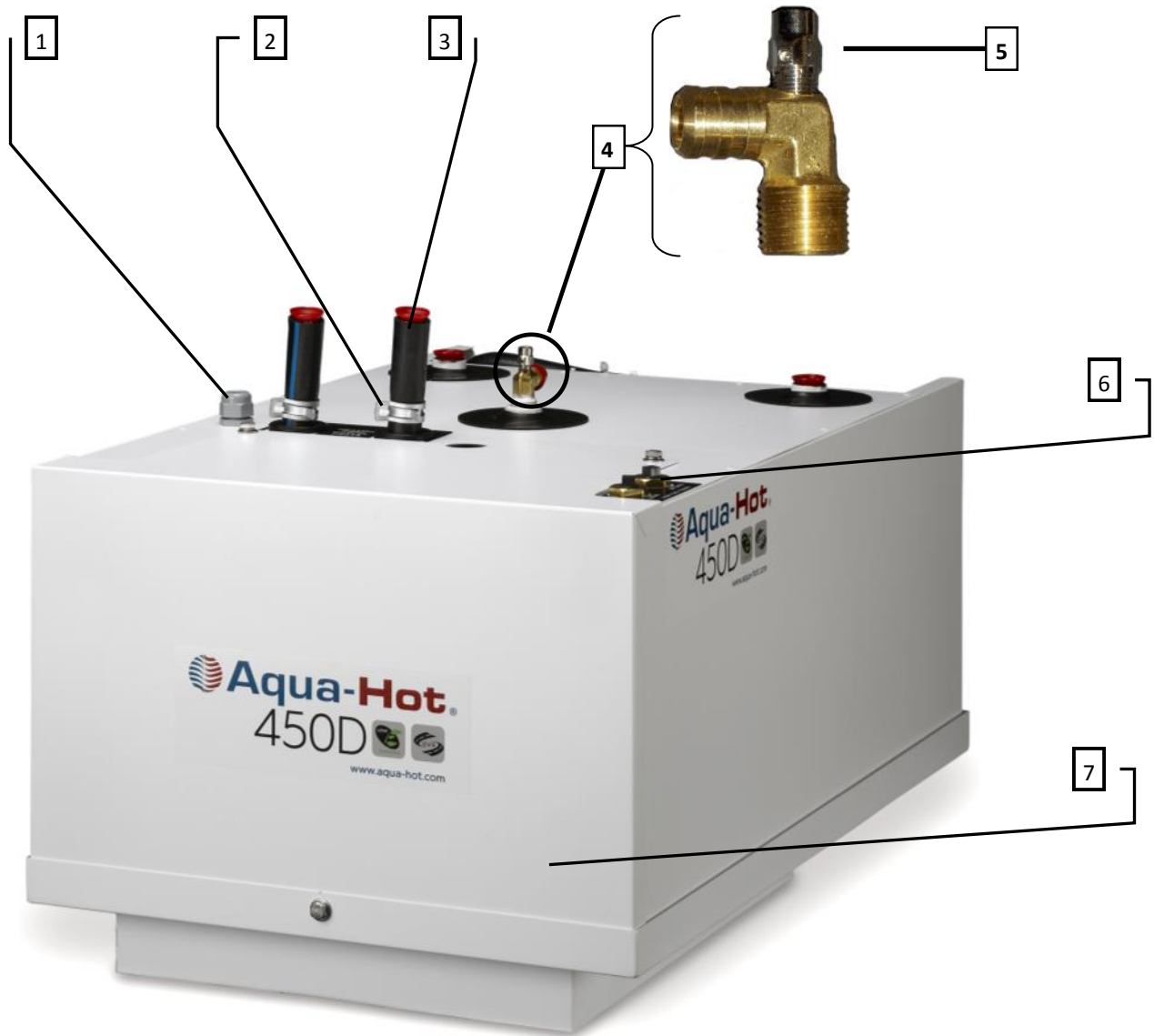

Key	Part Number	Serial Number	Description
1	HDX-000-623		Clamp, Romex, 1/2 in. Plastic
2	PLX-CTB-270		Clamp, Hose Constant Tension 3/4 in.
3	PLX-285-010		Hose, Heater, 3/4in x 3/4in 45° Molded Rubber
4	PLE-007-000		Valve, Air Assembly Comb, Coin/Key
5	PLX-007-065		Valve, Air Comb, Coin/Key
6	PLX-105-800		Fitting, Bulkhead, 1/4 x 1/4 in. (F) NPT Brass
7	SME-450-030		Cover, Access Main

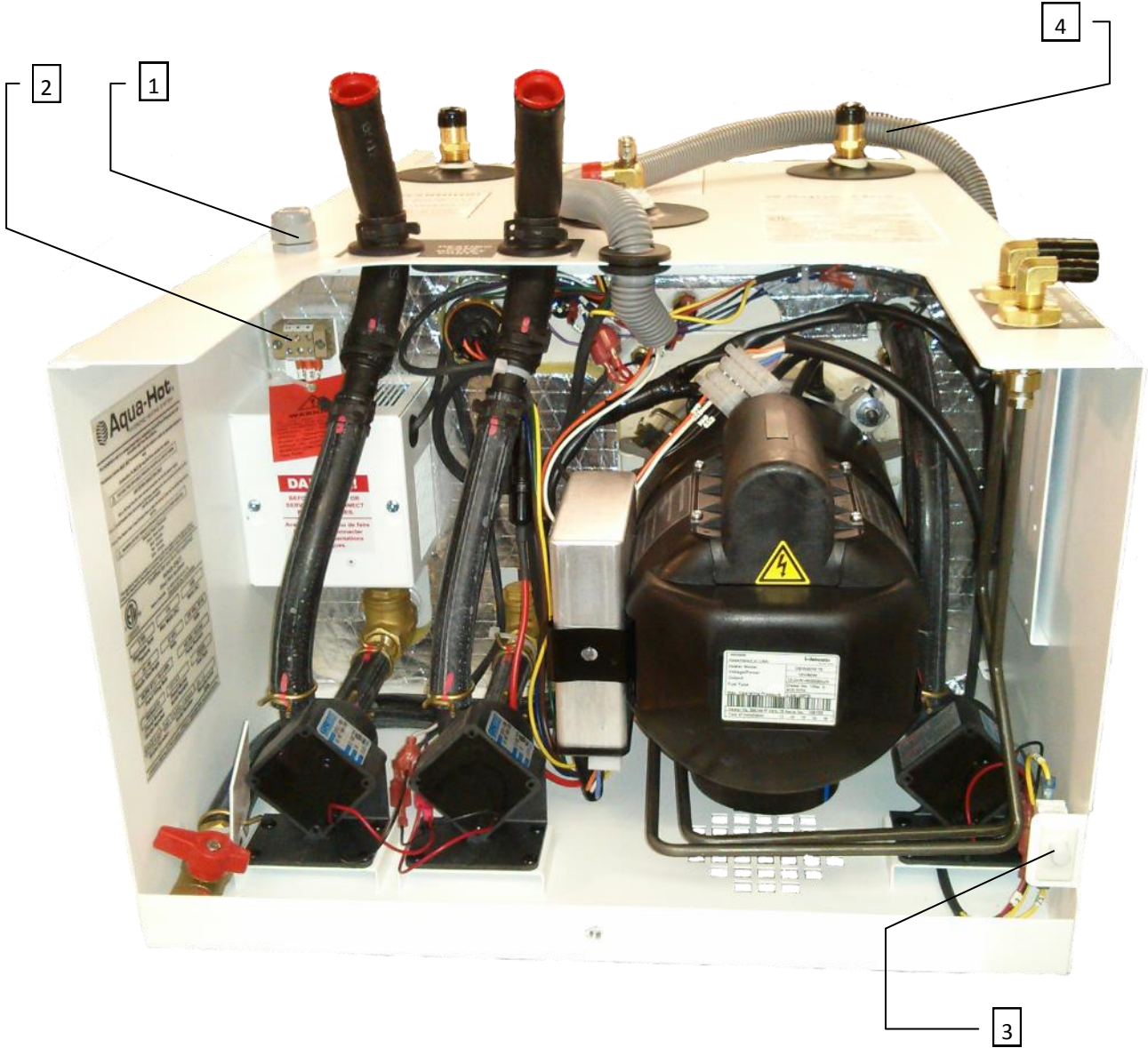

Key	Part Number	Serial Number	Description
1	HDX-000-623		Clamp, Romex 1/2" Plastic
2	ELE-000-905		Block, Terminal 3 Position 22-8 AWG
3	ELX-000-050		Switch, Interlock
4	ELE-100-455		Harness, Wiring 12 ft. Assembly

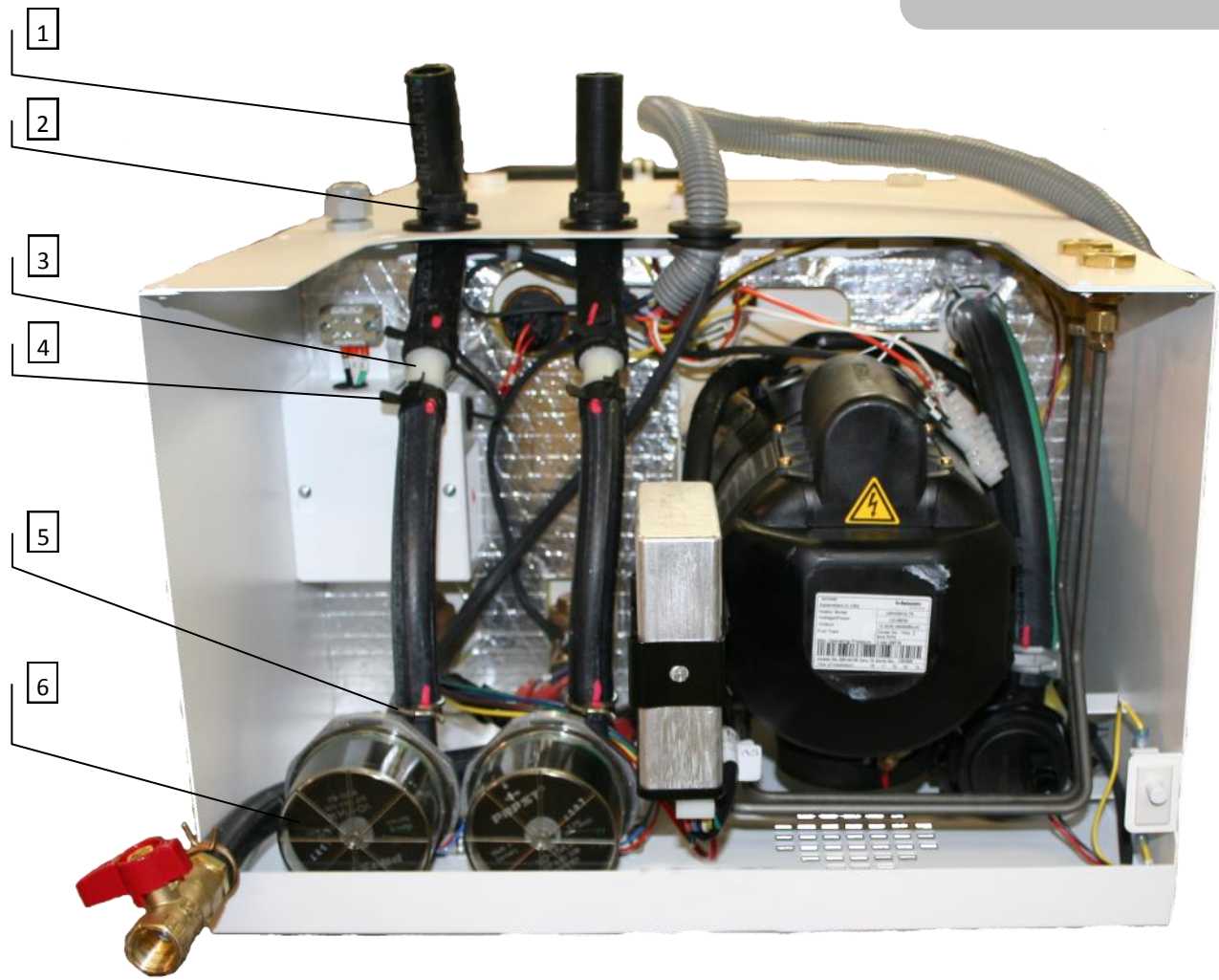

AHE-450-DE4			
Key	Part Number	Serial Number	Description
1	PLX-285-010		Hose, Heater, 3/4 in X 3/4 in 45° Molded Rubber
2	PLX-CTB-270		Clamp, Hose, Constant Tension, 3/4 in
3	PLX-000-815	A450-100277 - A450-110278	Fitting, Reducer 3/4 in x 1/2 in Black Nylon
4	PLX-CTB-230	A450-100277 - A450-110278	Clamp, Hose Constant Tension 7/8 in.
5	PLX-000-140	A450-100277 - A450-110278	Clamp, Hose Single Wire 7/8 in Steel
6	PLE-100-821	A450-100277 - A450-110278	Pump, Zone Circulation
AHE-450-DW3			
Key	Part Number	Serial Number	Description
1	PLX-285-010		Hose, Heater, 3/4 in X 3/4 in 45° Molded Rubber
2	PLX-CTB-270		Clamp, Hose, Constant Tension, 3/4 in
3	PLX-000-815	A450-100294 - A450-110265	Fitting, Reducer 3/4 in x 1/2 in Black Nylon
4	PLX-CTB-230	A450-100294 - A450-110265	Clamp, Hose Constant Tension 7/8 in.
5	PLX-000-140	A450-100294 - A450-110265	Clamp, Hose Single Wire 7/8 in Steel
6	PLE-100-821	A450-100294 - A450-110265	Pump, Zone Circulation

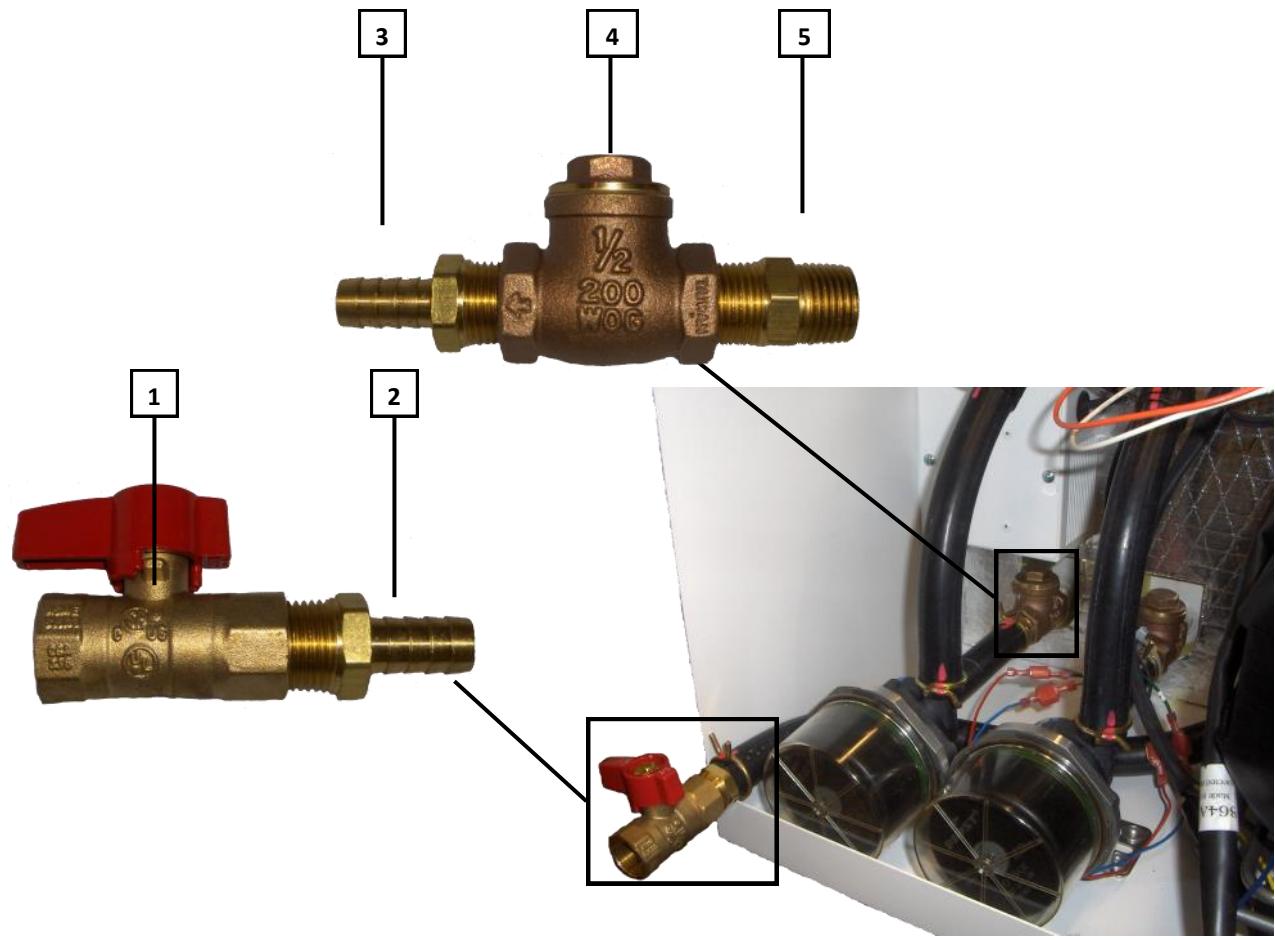

AHE-450-DE4			
Key	Part Number	Serial Number	Description
1	PLX-BV1-200		Valve, Ball 1/2(F) NPT
2	PLX-699-330		Fitting, Brass, Barb 1/2 X 1/2 (M)NPT
3	PLX-699-330	A450-100277 - A450-110278	Fitting, Brass, Barb 1/2 X 1/2 (M)NPT
4	PLX-2A1-300		Valve, Brass Check, 1/2 X 1/2 (F)NPT
5	PLX-122-00		Fitting, Brass, Close Nipple 1/2 (M)NPT w/Hex
AHE-450-DW3			
3	PLX-699-330	A450-100294 - A450-110265	Fitting, Brass, Barb 1/2 X 1/2 (M)NPT

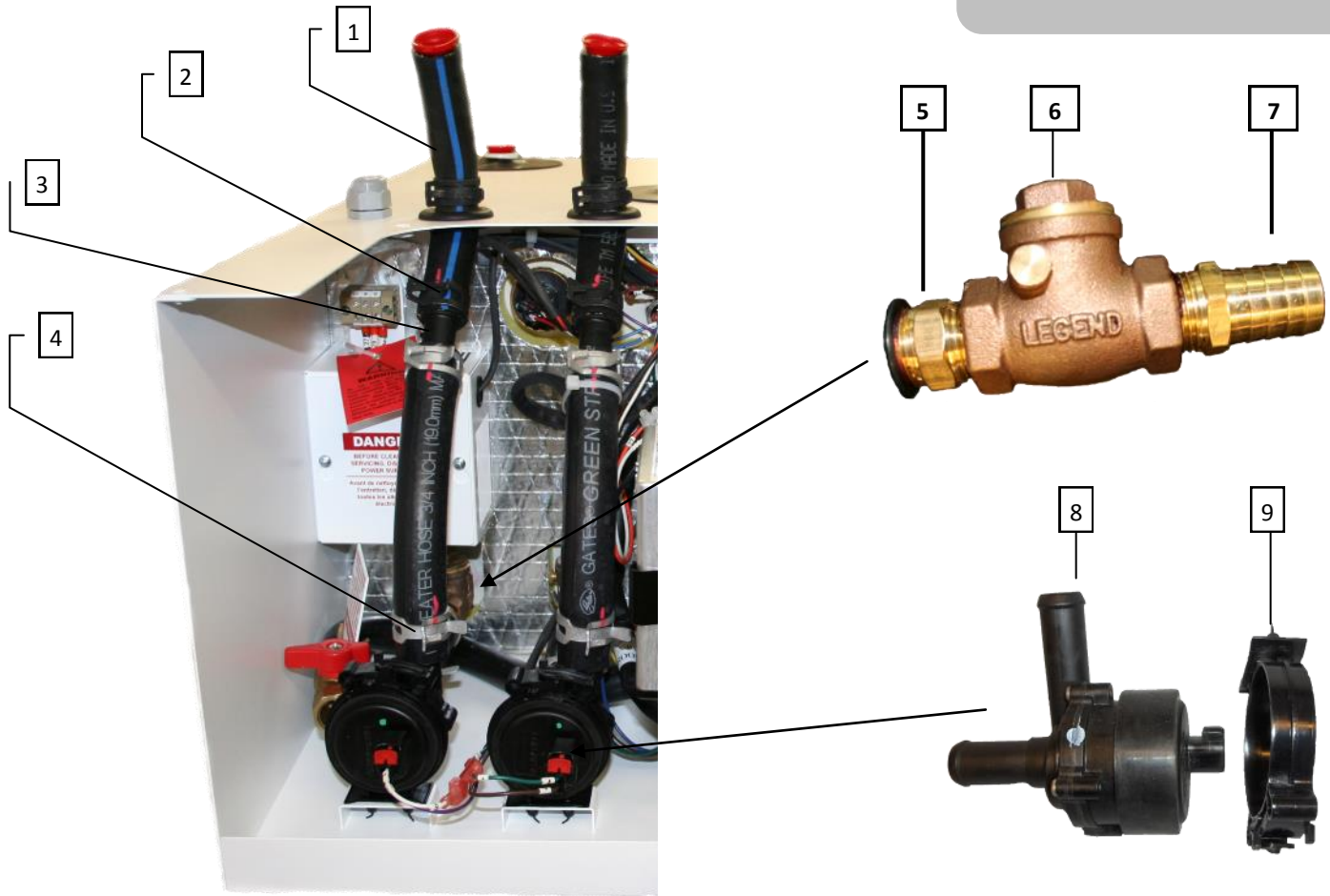

AHE-450-DE4			
Key	Part Number	Serial Number	Description
1	PLX-285-010		Hose, Heater, 3/4 in x 3/4 in 45° Molded Rubber
2	PLX-CTB-270		Clamp, Hose, Constant Tension, 3/4 in.
3	PLX-000-825	450-110279 - A450-130591	Fitting, Couple 3/4 in Black Nylon
4	PLX-CTB-290	450-110279 - A450-130591	Clamp, Hose, Constant Tension 1 1/16 diameter
5	PLX-122-000		Fitting, Brass, Close Nipple, 1/2 in (M) NPT w/ Hex
6	PLX-2A1-300		Valve, Brass, Check 1/2 in. x 1/2 in. (F) NPT
7	PLX-A65-200	A450-110279 - A450-130591	Fitting, Brass, Barb, 3/4 in x 1/2 in (M) NPT
8	PLX-100-835	A450-110279 - A450-130591	Pump, Cooper Standard
9	PLX-100-836	A450-110279 - A450-130591	Bracket, Cooper, Pump Mounting
AHE-450-DW3			
3	PLX-000-825	A450-110266 - A450-130582	Fitting, Couple 3/4 in Black Nylon
4	PLX-CTB-290	A450-110266 - A450-130582	Clamp, Hose, Constant Tension 1 1/16 diameter
7	PLX-A65-200	A450-110266 - A450-130582	Fitting, Brass, Barb, 3/4 in x 1/2 in (M) NPT
8	PLX-100-835	A450-110266 - A450-130582	Pump, Cooper Standard
9	PLX-100-836	A450-110266 - A450-130582	Bracket, Cooper, Pump Mounting

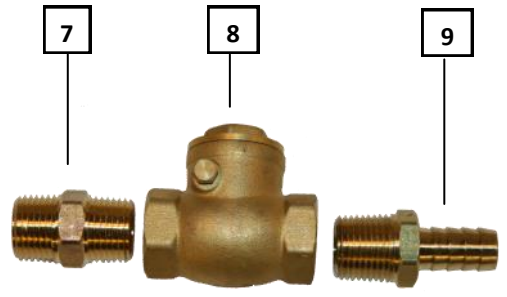
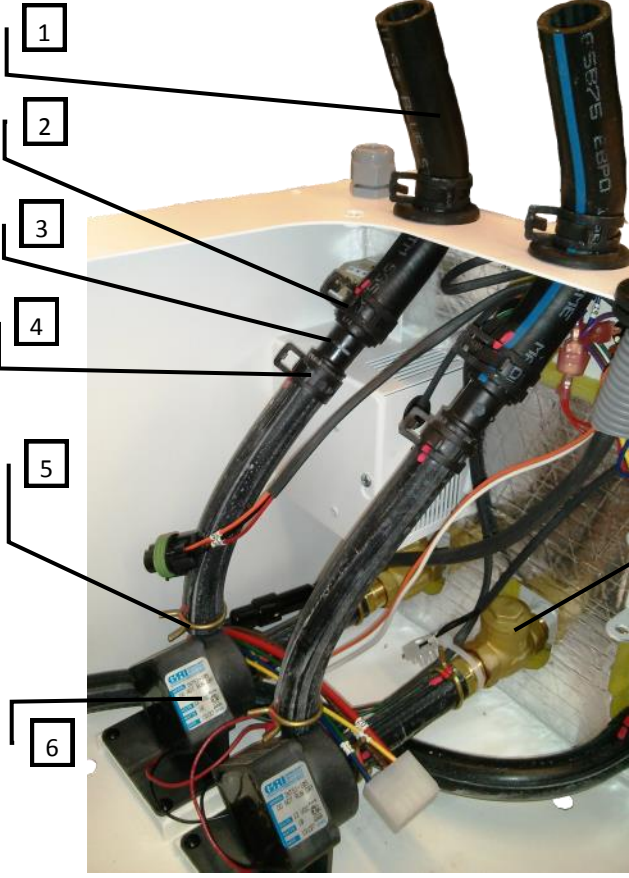

AHE-450-DE4			
Key	Part Number	Serial Number	Description
1	PLX-285-010		Hose, Heater, 3/4 in x 3/4 in 45° Molded Rubber
2	PLX-CTB-270		Clamp, Hose, Constant Tension, 3/4 in.
3	PLX-000-815	A450-130592- Current	Fitting, Adapter, .75 to .5 Hose
4	PLX-CTB-230	A450-130592- Current	Clamp, Hose, Constant Tension 7/8 in.
5	PLX-000-140	A450-130592- Current	Clamp, Hose, Single Wire 7/8 in. Steel
6	PLX-100-850	A450-130592- Current	Pump, GRI, INTG1 - 053, 12 VDC 18W
7	PLX-122-000		Fitting, Brass, Close Nipple, 1/2 in (M) NPT w/ Hex
8	PLX-2A1-300		Valve, Brass, Check 1/2 in. x 1/2 in. (F) NPT
9	PLX-699-330	A450-130592- Current	Fitting, Barb, 1/2 in. x 1/2 in (M) NPT, Brass
AHE-450-DW3			
3	PLX-000-815	A450-130583- Current	Fitting, Adapter, .75 to .5 Hose
4	PLX-CTB-230	A450-130583- Current	Clamp, Hose, Constant Tension 7/8 in.
5	PLX-000-140	A450-130583- Current	Clamp, Hose, Single Wire 7/8 in. Steel
6	PLX-100-850	A450-130583- Current	Pump, GRI, INTG1 - 053, 12 VDC 18W
9	PLX-699-330	A450-130583- Current	Fitting, Barb, 1/2 in. x 1/2 in (M) NPT, Brass

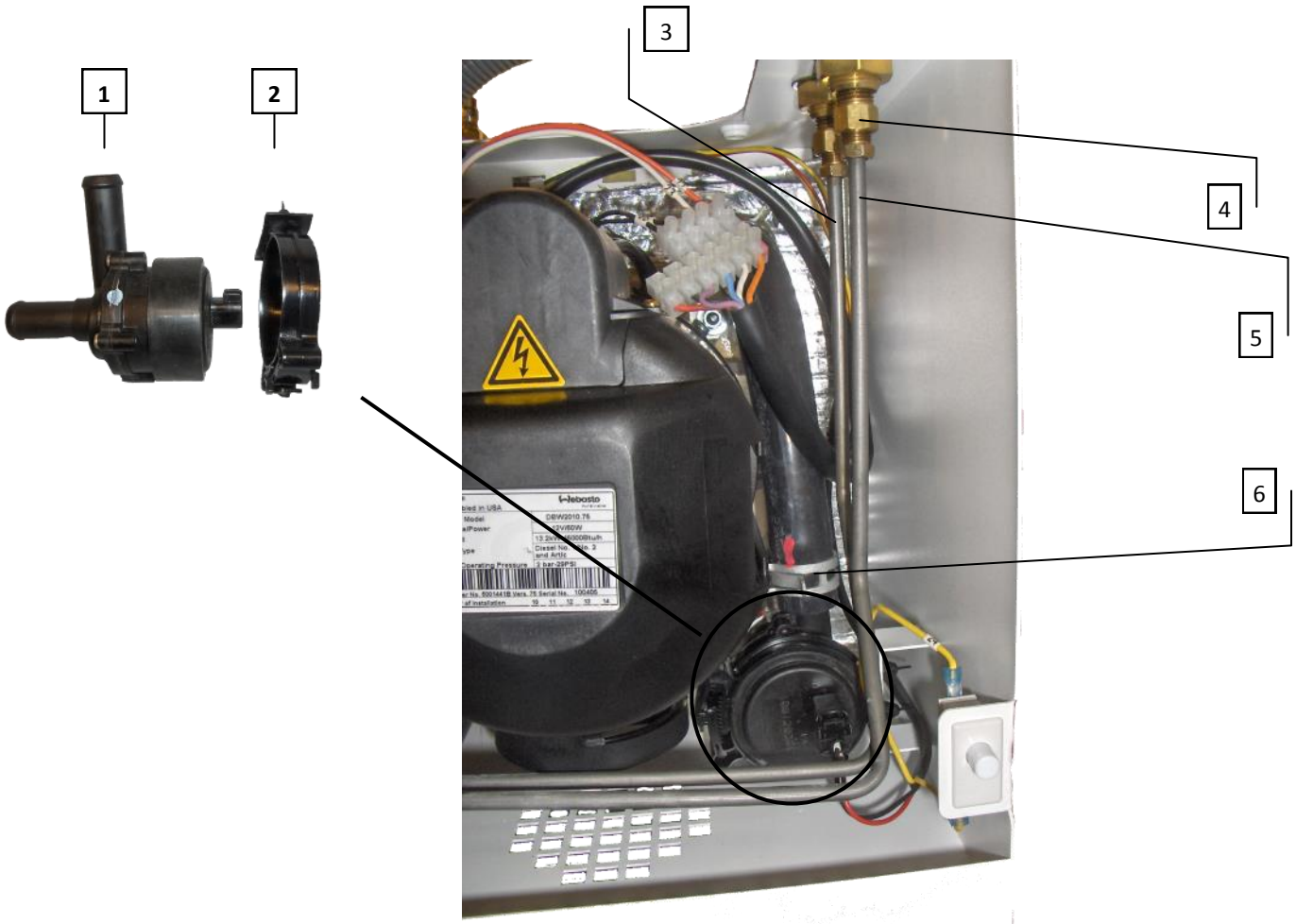

AHE-450-DE4			
Key	Part Number	Serial Number	Description
1	PLX-100-835	A450-100277 - A450-130591	Pump, Cooper Standard
2	PLX-100-836	A450-100277 - A450-130591	Bracket, Cooper Pump Mounting
3a	FLE-421-852-FRU	A450-100277 - A450-120993	Kit, Fuel Line Replacement 400/450
3b	FLE-421-852	A450-120994 - Current	Tube, Return Fuel Line Assembly
4	FLX-421-000		Fitting, Inverted Flare Connector 1/4 Tube x 1/4 (M) NPT
5	FLE-421-851		Tube, Supply Fuel Line Assembly
6	PLX-CTB-290	A450-100277 - A450-130591	Clamp, Hose Constant Tension 1 1/16 in diameter
AHE-450-DW3			
Key	Part Number	Serial Number	Description
1	PLX-100-835	A450-100277 - A450-130591	Pump, Cooper Standard
2	PLX-100-836	A450-100277 - A450-130591	Bracket, Cooper Pump Mounting
3a	FLE-421-852-FRU	A450-100277 - A450-120993	Kit, Fuel Line Replacement 400/450
3b	FLE-421-852	A450-120994 - Current	Tube, Return Fuel Line Assembly
6	PLX-CTB-290	A450-100277 - A450-130591	Clamp, Hose Constant Tension 1 1/16 in diameter

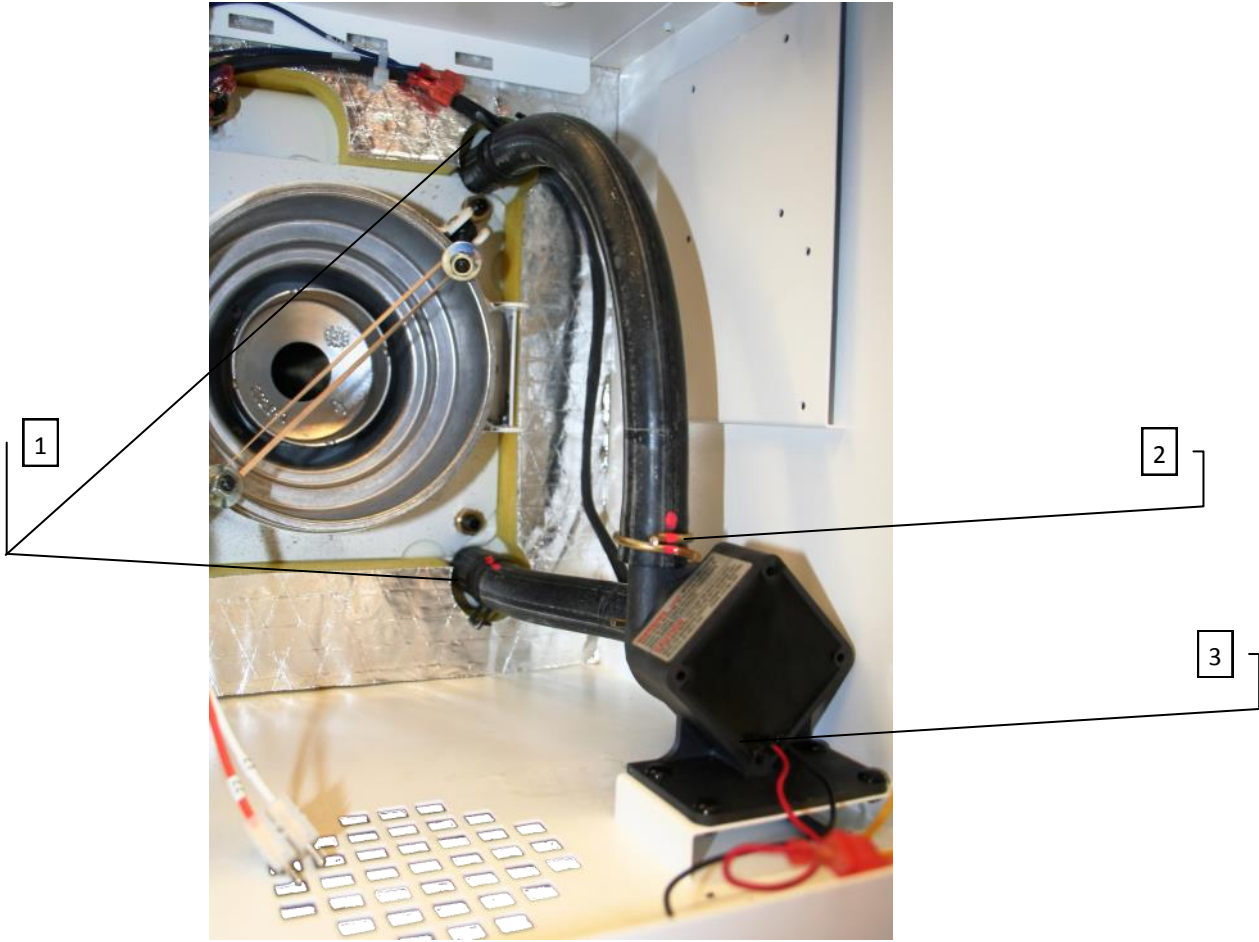

AHE-450-DE4			
Key	Part Number	Serial Number	Description
1	PLX-CTB-230	A450-130592- Current	Clamp, Hose, Constant Tension 7/8 in.
2	PLX-000-140	A450-130592- Current	Clamp, Hose, Single Wire 7/8 in. Steel
3	PLX-100-850	A450-130592- Current	Pump, GRI, INTG1-053, 12 VDC 18W
AHE-450-DW3			
Key	Part Number	Serial Number	Description
1	PLX-CTB-230	A450-130583- Current	Clamp, Hose, Constant Tension 7/8 in.
2	PLX-000-140	A450-130583- Current	Clamp, Hose, Single Wire 7/8 in. Steel
3	PLX-100-850	A450-130583- Current	Pump, GRI, INTG1-053, 12 VDC 18W

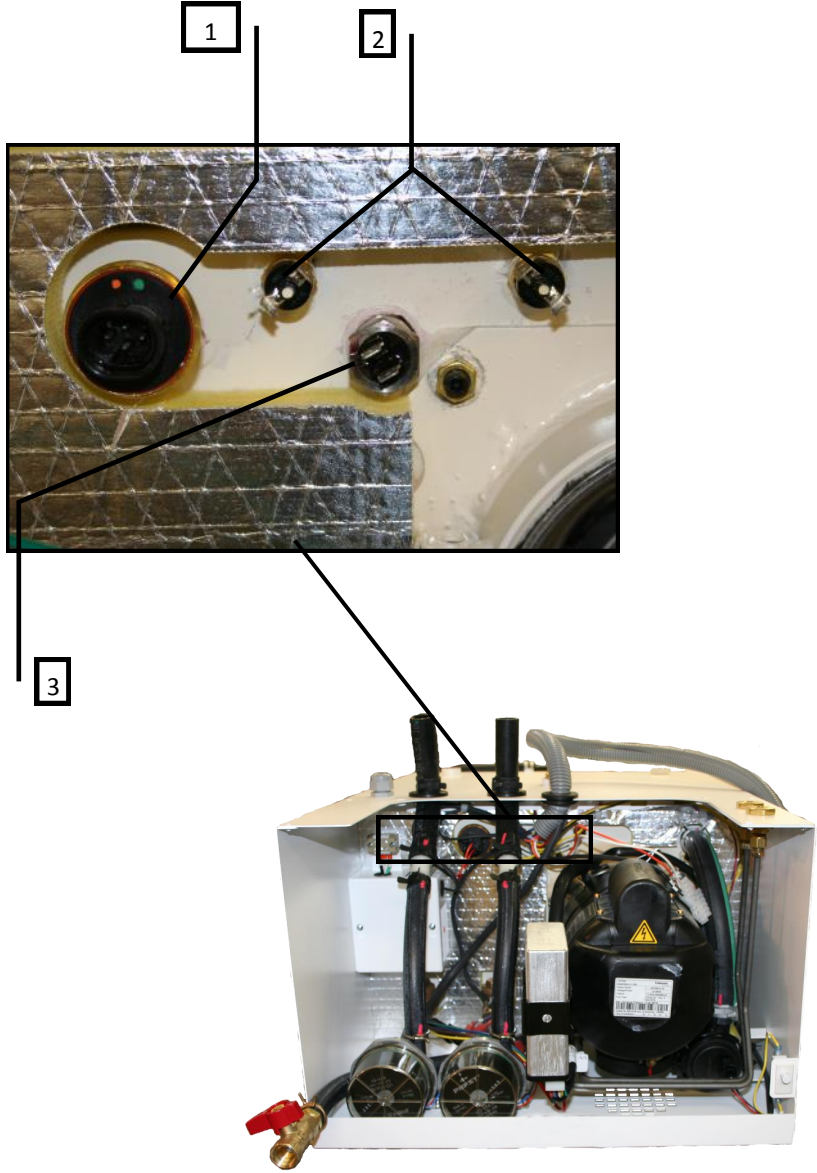

AHE-450-DE4			
Key	Part Number	Serial Number	Description
1	ELX-800-003	A450-100277 - A450-131234	Switch, Fluid Level Capacitance
2	ELE-HLT-425		Thermostat, High Limit 215°F w/Spade Connectors
3	ELE-014-005		Thermostat, Control 185°F 1/2 in. (M) NPT
AHE-450-DW3			
1	ELX-800-003	A450-100294 - A450-131242	Switch, Fluid Level Capacitance

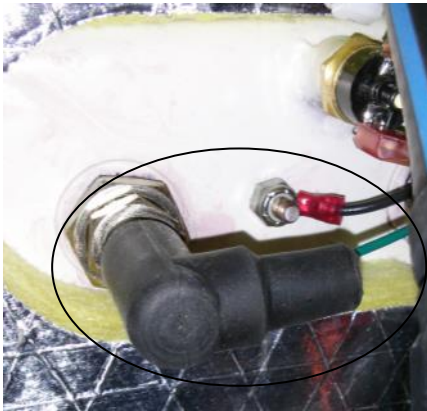

AHE-450-DE4			
Key	Part Number	Serial Number	Description
1	ELX-800-005	A450-131235 - Current	Switch, Fluid Level Conductive
2	ELX-AMP-005	A450-131235 - Current	Circuit, Amp
AHE-450-DW3			
1	ELX-800-005	A450-131243 - Current	Switch, Fluid Level Conductive
2	ELX-AMP-005	A450-131243 - Current	Circuit, Amp

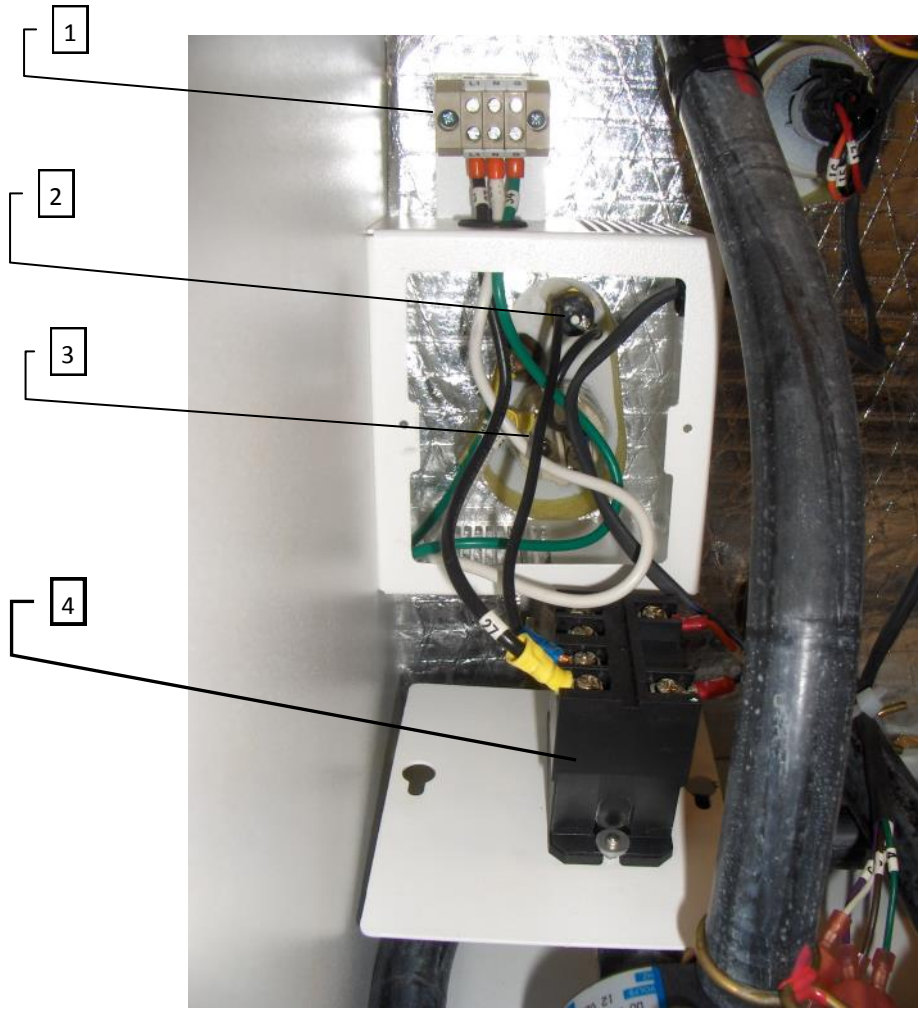

Key	Part Number	Serial Number	Description
1	ELE-000-905		Block, Terminal, 3 Position 22-8 AWG
2	ELE-000-616-FRU		Thermostat, High Limit VAC 215°F
3	ELX-2E7-540		Element, Electric Heating, 120 VAC/1650 Watt
4	ELX-630-001		Relay, 30 A 277 VAC 12VCD Coil

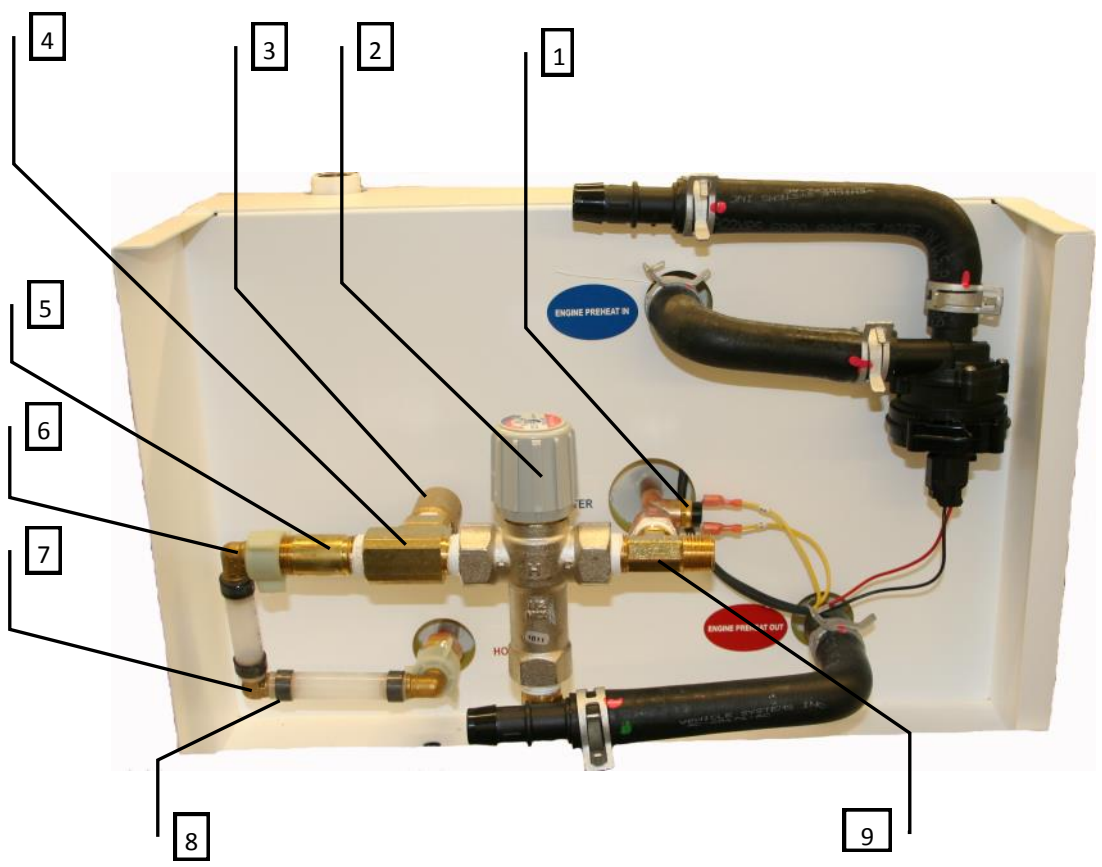

Key	Part Number	Serial Number	Description
1	ELE-LTC-608		Thermostat, Low Temp. Cut-Off w/Spade Connectors
2	PLX-09P-100		Valve, Tempering 145°F
3	PLX-111-125		Valve, Pressure Relief, 125 PSI
4	PLX-0X1-07D		Fitting, Tee, 1/2 in. NPT (M) (F) Brass
5	PLX-113-250		Fitting, Nipple, 1/2 in. NPT x 2-1/2 in. Brass
6	PLX-000-755		Fitting, Elbow, Swivel 1/2 in. Barb x 1/2 in. FPT
7	PLX-000-750		Fitting, Elbow 1/2 in. Barb, Brass
8	PLX-000-745		Ring, Crimp 1/2 in.
9	PLX-M10-1DA		Fitting, Tee Forged, 1/2 in (M) NPT

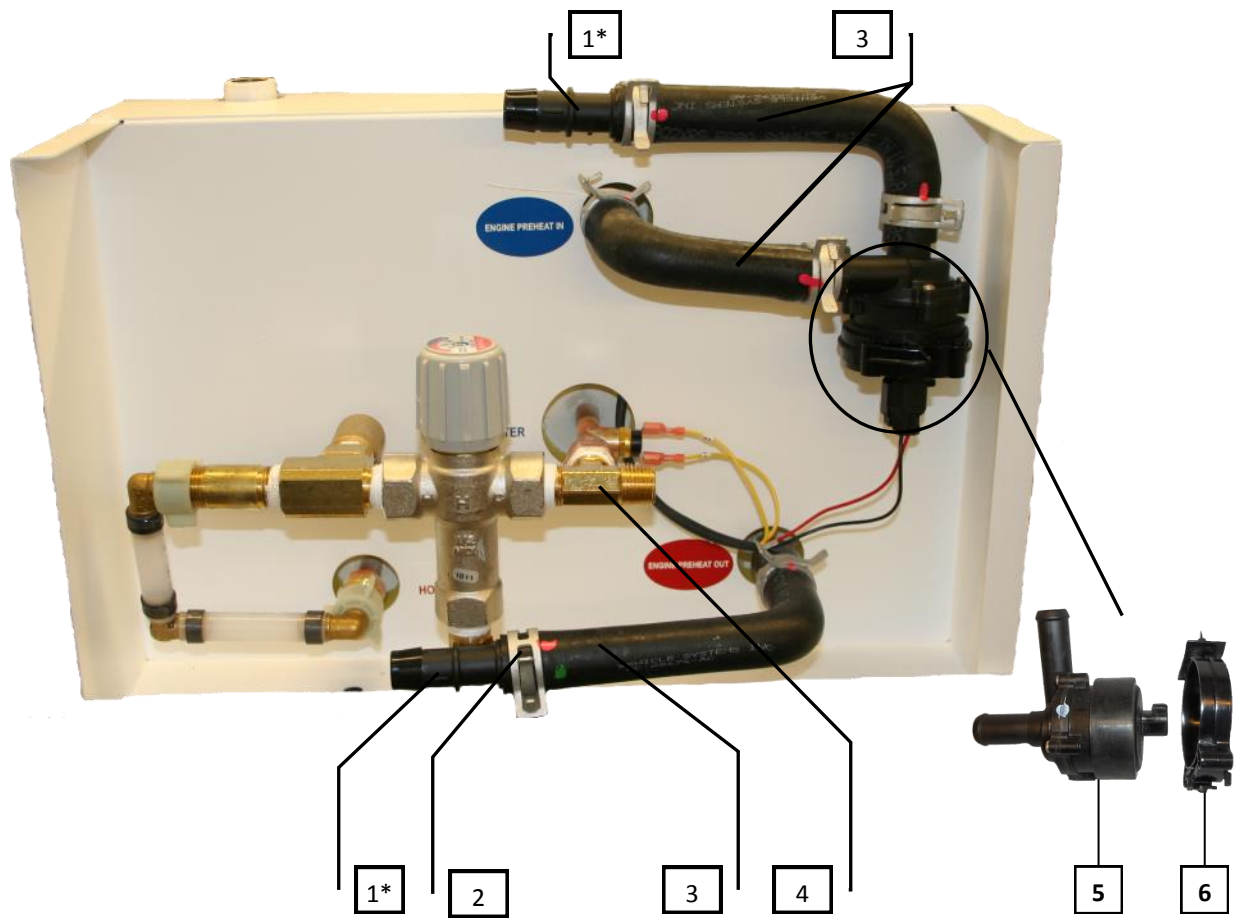

AHE-450-DE4			
Key	Part Number	Serial Number	Description
1	PLX-000-825	A450-100277 - A450-130591	Fitting, Coupler 3/4in Black Nylon
2	PLX-CTB-270	A450-100277 - A450-130591	Clamp, Hose Constant Tension 3/4 in
3	PLX-284-74V	A450-100277 - A450-130591	Hose, Molded, Elbow 90° 3/4in x 3/4in x 10in long
4	PLX-M10-1DA	A450-100277 - A450-130591	Fitting, Tee Forged, 1/2 Male NPT
5	PLX-100-835	A450-100277 - A450-130591	Pump, Cooper Standard
6	PLX-100-836	A450-100277 - A450-130591	Bracket, Cooper Pump Mounting
AHE-450-DW3			
Key	Part Number	Serial Number	Description
1*	PLX-000-815	A450-100294 - A450-130582	Fitting, Adapter 3/4 to 1/2 hose
2	PLX-CTB-270	A450-100294 - A450-130582	Clamp, Hose Constant Tension 3/4 in
3	PLX-284-74V	A450-100294 - A450-130582	Hose, Molded, Elbow 90° 3/4in x 3/4in x 10in long
4	PLX-M10-1DA	A450-100294 - A450-130582	Fitting, Tee Forged, 1/2 Male NPT
5	PLX-100-835	A450-100294 - A450-130582	Pump, Cooper Standard
6	PLX-100-836	A450-100294 - A450-130582	Bracket, Cooper Pump Mounting

* The AHE-450-DW3 uses a 3/4 to 1/2 reducer fitting for the engine preheat connection

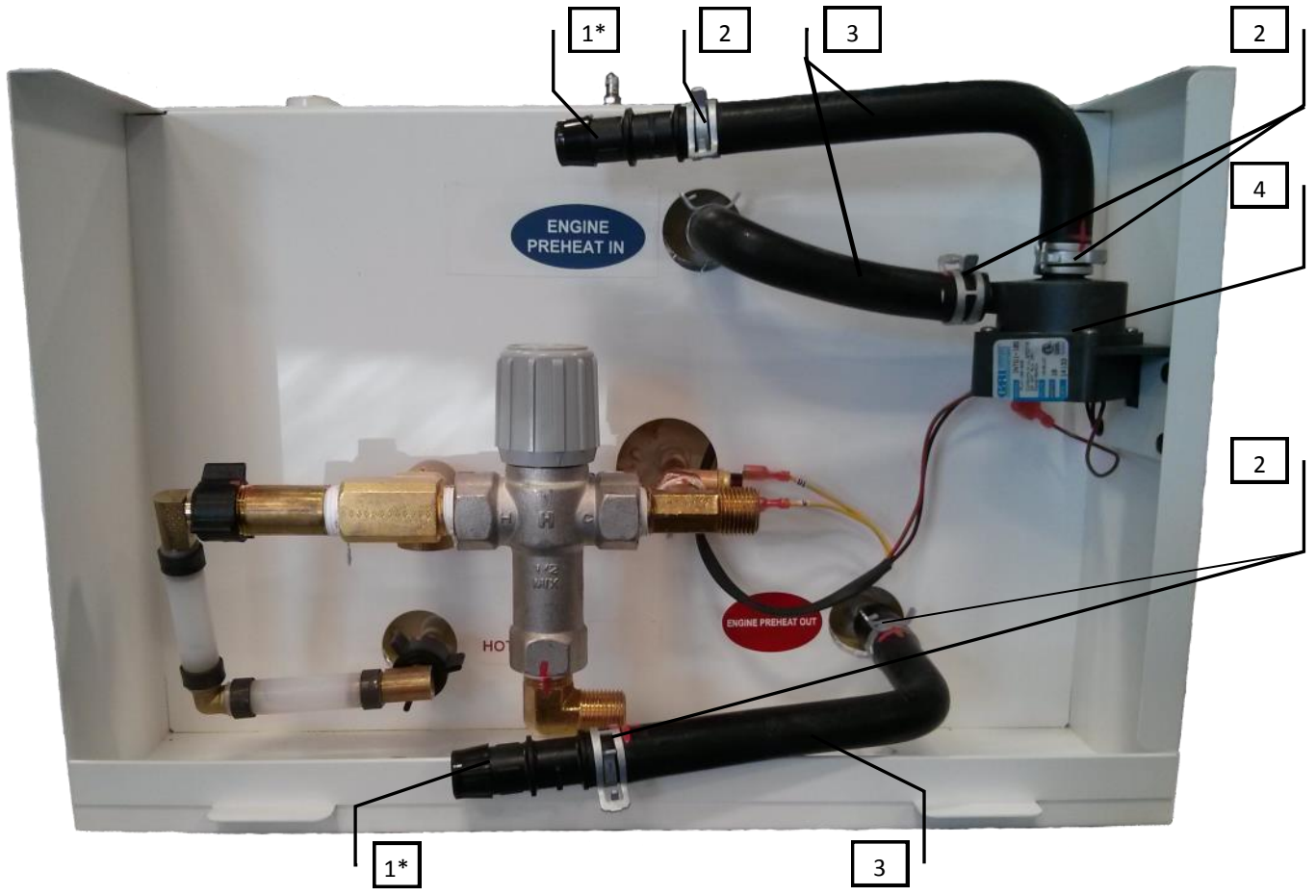

AHE-450-DE4

Key	Part Number	Serial Number	Description
1	PLX-000-815	A450-130592- Current	Adapter, Hose ,3/4in. X 1/2 in. Plastic
2	CTN-22ST-FS	A450-130592- Current	Clamp, 1/2" Hose Band, Formed Tubing
3	PLX-285-000	A450-130592- Current	Hose, Heater 1/2 in. to 1/2 in. 90° Molded
4	PLX-100-850	A450-130592- Current	Pump, GRI, INTG1-053, 12 VDC 18W

AHE-450-DW3

Key	Part Number	Serial Number	Description
1*	PLX-450-002	A450-130583- Current	Adaptor, Hose ,1/2 in. x 5/8 in. Plastic
2	CTN-22ST-FS	A450-130583- Current	Clamp, 1/2" Hose Band, Formed Tubing
3	PLX-285-000	A450-130583- Current	Hose, Heater 1/2 in. to 1/2 in. 90° Molded
4	PLX-100-850	A450-130583- Current	Pump, GRI, INTG1-053, 12 VDC 18W

* The AHE-450-DW3 uses a 3/4 to 1/2 reducer fitting for the engine preheat connection

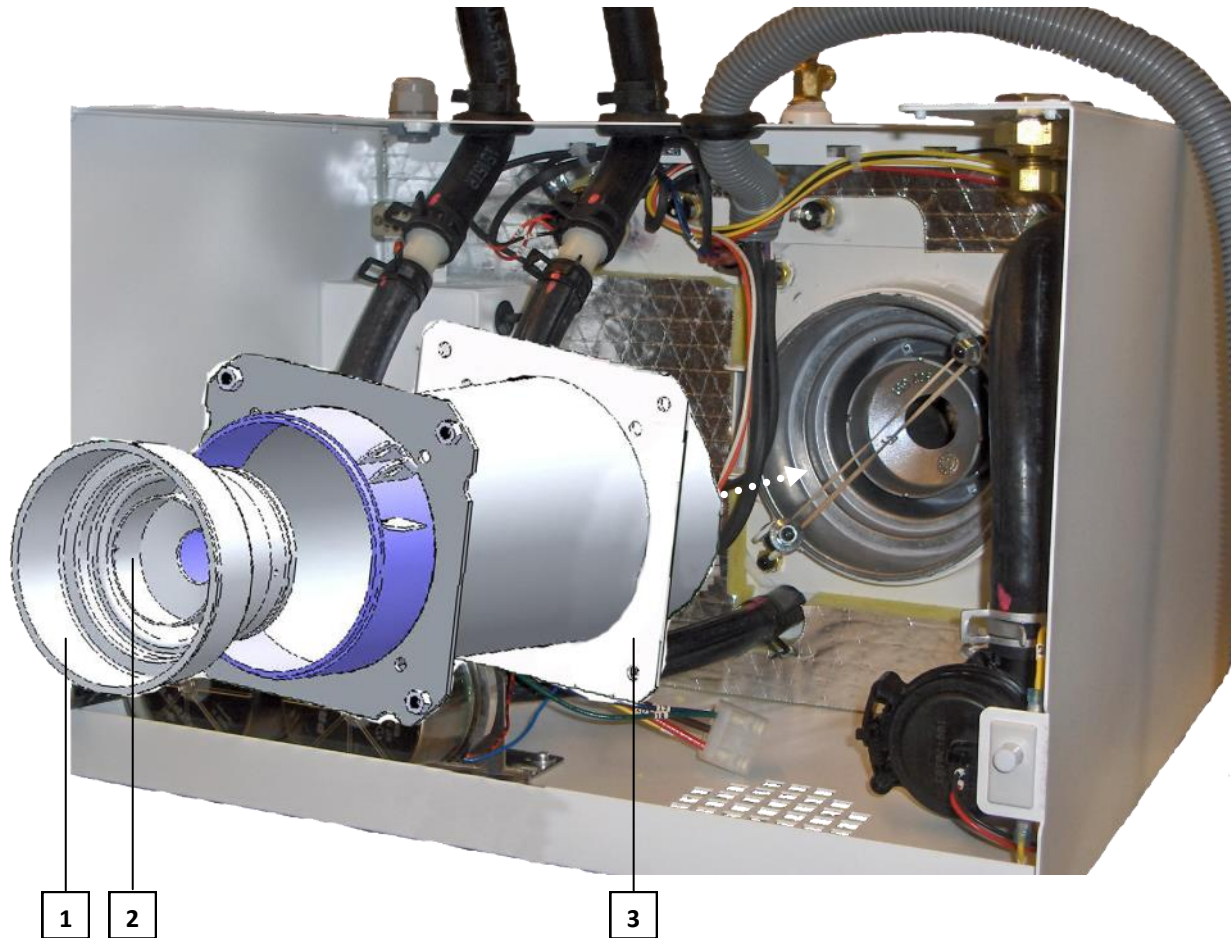

Key	Part Number	Serial Number	Description
1	WPX-302-828		Housing, Swirler, DBW 2010
2	WPX-302-651		Air Swirler, DBW 2010
3	HDE-700-205		Gasket, Combustion Chamber Tube

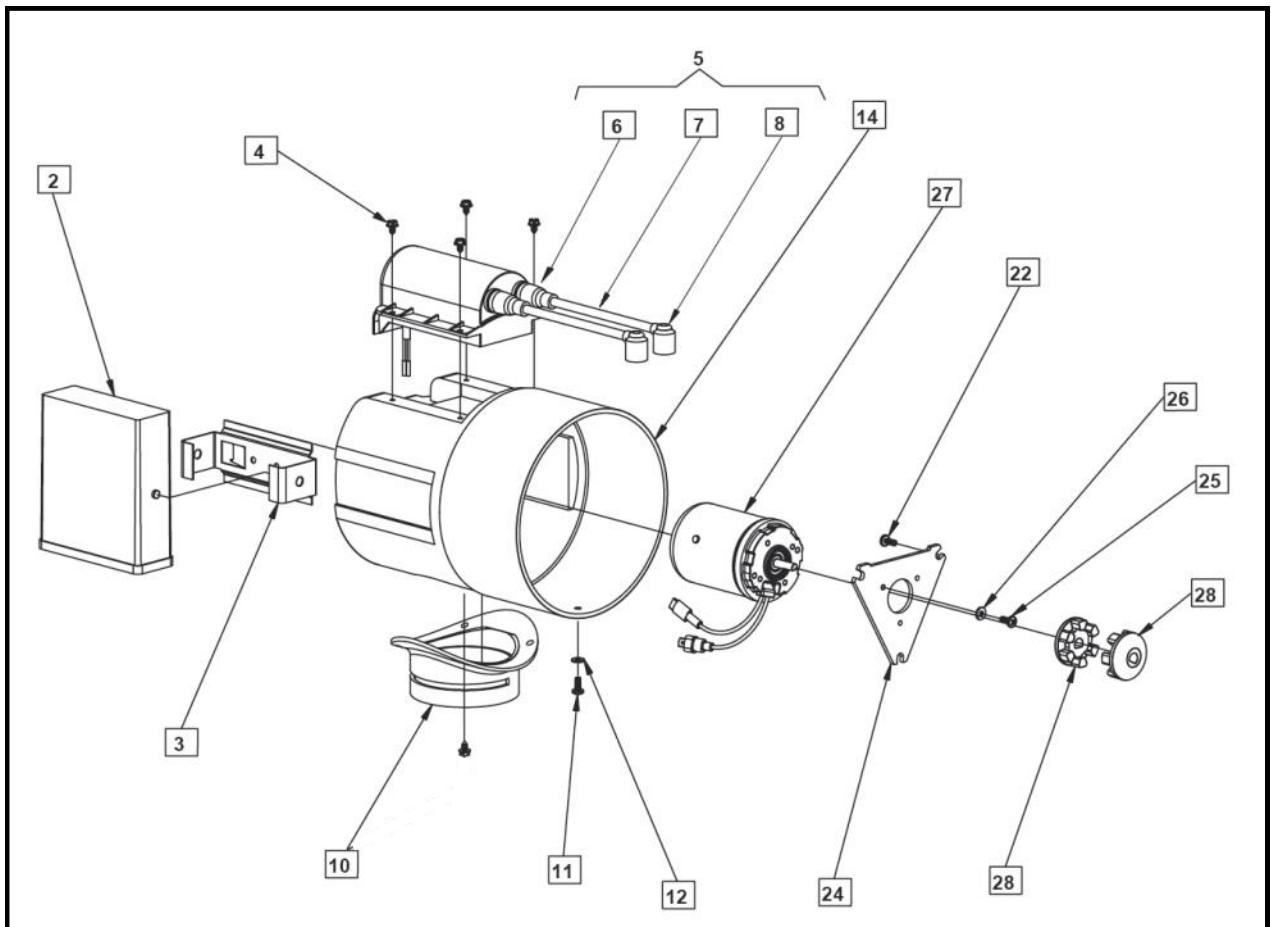

Key	Part Number	Description
2	WPX-287-962	Controller, Diesel Burner, 12 VDC
3	WPX-362-107	Bracket, Controller Mounting
4	WPX-470-562	Screw, Coil Mounting
5	WPX-101-838	Coil, Ignition, 12 VDC
6	WPX-404-918	Boot, Ignition Wire
7	WPX-178-624	Wire, Ignition
8	WPX-176-494	Boot Ignition Wire, Elbow
10	WPX-350-427	Shutter, Combustion Air Intake
11	WPX-432-377	Screw, Protection Housing
12	WPX-152-269	Washer, Star, Protection Housing
14	WPX-436-216	Cap, Protection, Motor
22	WPX-147-834	Screw, Flange, Blower Housing
24	WPX-425-05A	Plate, Motor Mounting
25	WPX-432-377	Screw, Motor Plate
26	WPX-152-269	Washer, Star, Motor Plate
27	WPX-425-060	Motor, Combustion Air/Fuel Pump, 12 VDC
28	WPX-350-516	Clutch, Half, 6mm

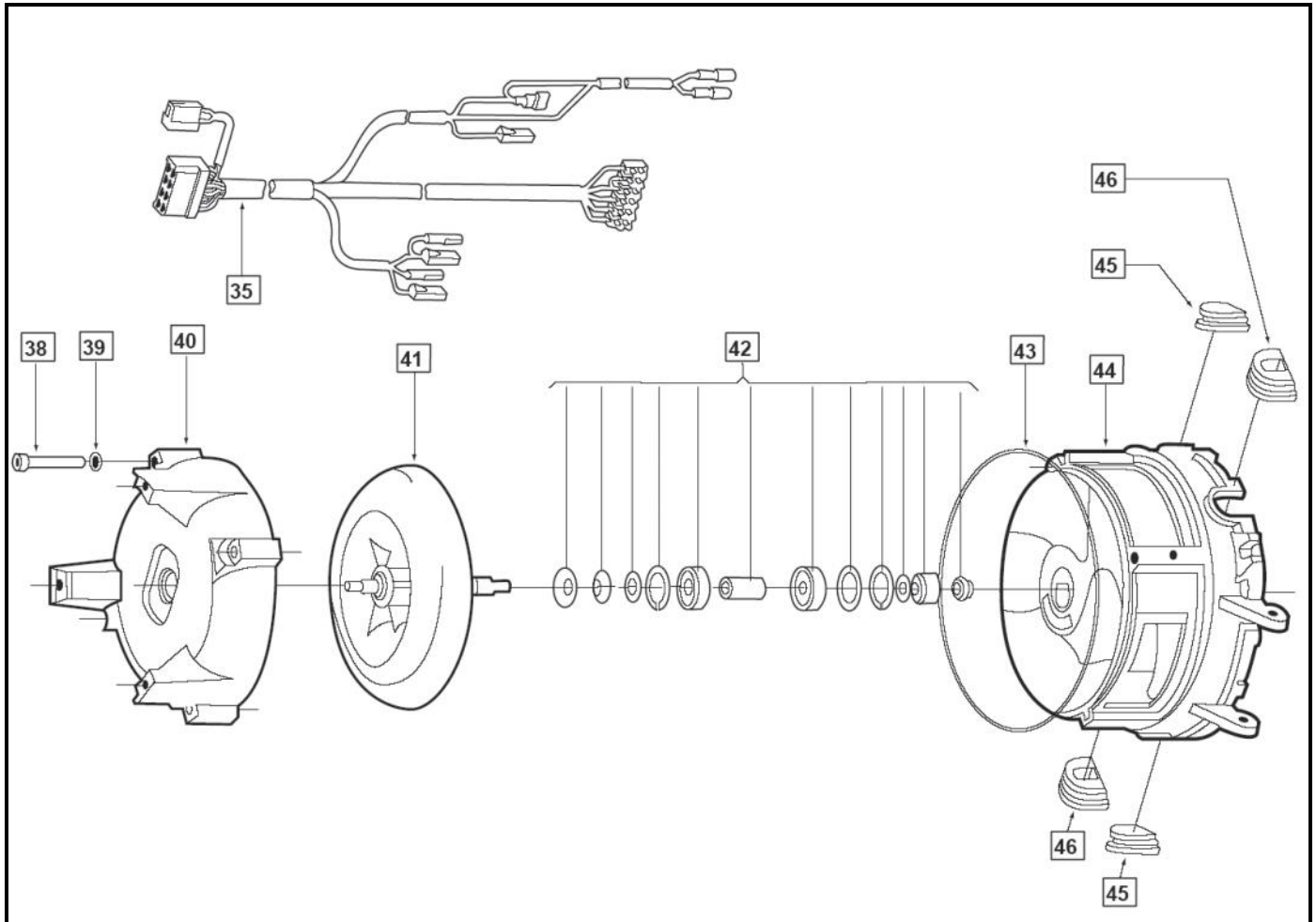

Key	Part Number	Description
35	WPX-434-795	Harness, C-Plug
38	WPX-148-210	Screw, Blower Casting
39	WPX-152-552	Washer, Lock, Blower Casting
40	WPX-301-841	Housing, Blower
41	WPX-373-001	Blower, Wheel w/ Shaft
42	WPX-378-313	Bearing Kit
43	WPX-412-244	O-Ring Blower Casting
44	WPX-225-67A	Casting, Blower
45	WPX-298-964	Grommet, Blower Casting, Left
46	WPX-299-995	Grommet, Blower Casting, Right

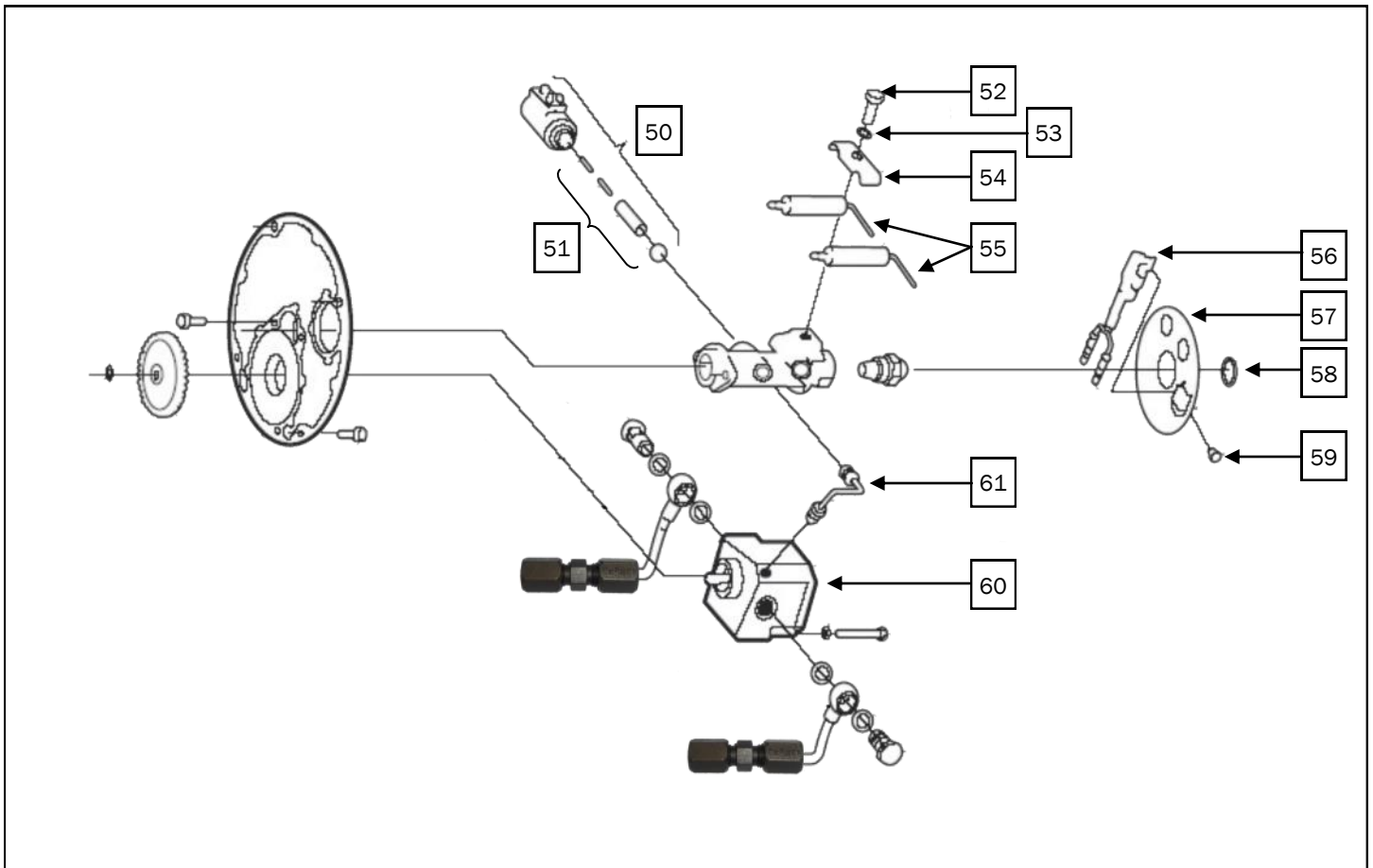

Key	Part Number	Description
50	WPX-322-083	Valve, Fuel Solenoid, 12 VDC
51	WPX-386-650	Valve, Fuel Solenoid, Kit
52	WPX-267-279	Bolt, Electrode
53	WPX-152-560	Washer, Lock, Electrode
54	WPX-278-971	Clamp, Electrode
55	WPX-274-313	Electrode, Ignition
56	WPX-638-78A	Sensor, Flame
57	WPX-887-71A	Disc, Photo
58	WPX-453-048	Clip, Retaining, Photo Disc
59	WPX-147-699	Screw, Flame Sensor
60	WPX-503-03A	Pump, Fuel, Kit
61	WPX-665-49A	Tube, Fuel, High Pressure

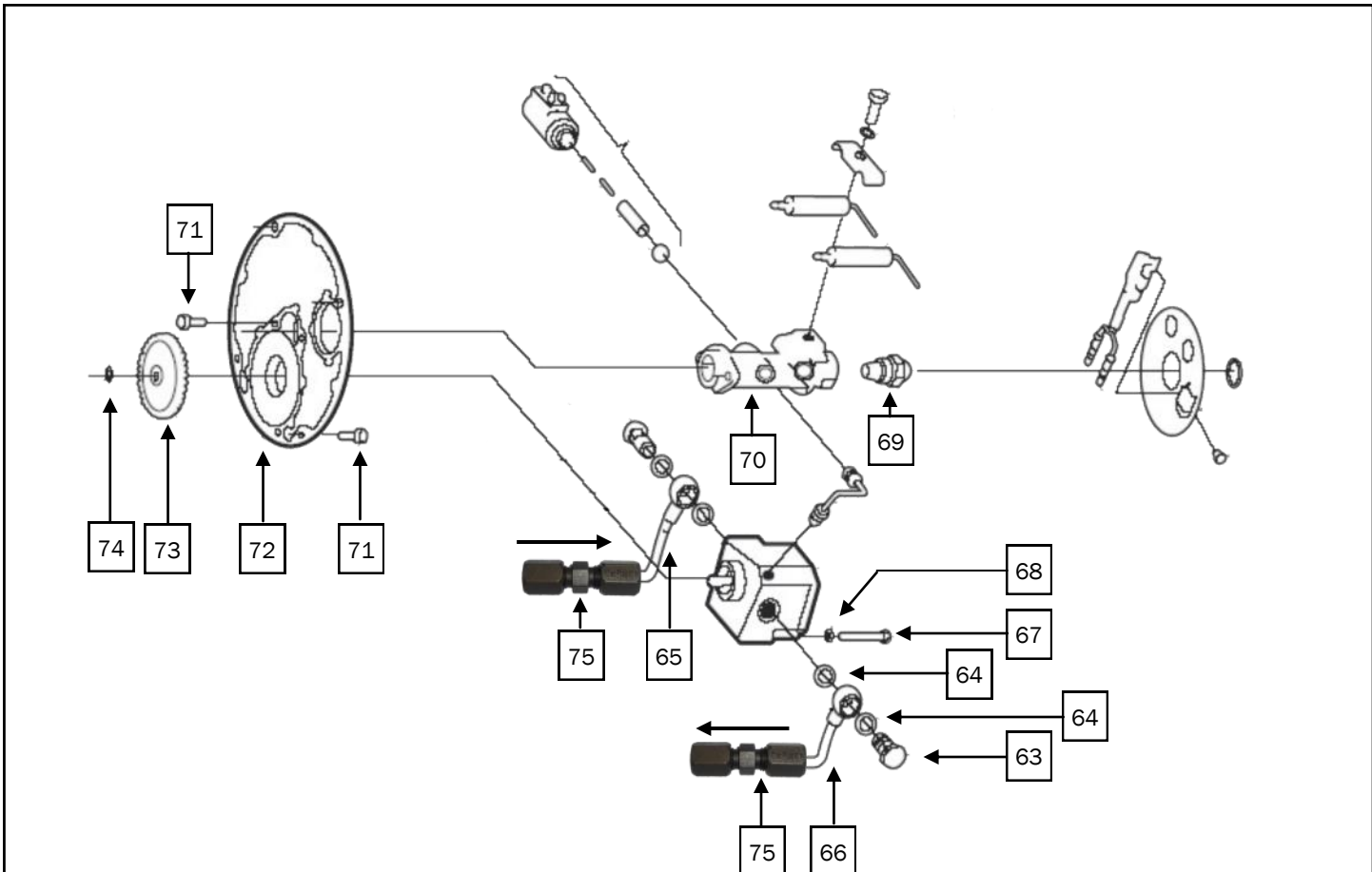

Key	Part Number	Description
63	WPX-150-754	Bolt, Banjo
64	WPX-151-157	Gasket, Ring, Copper
65	WPX-661-002	Pipe, Fuel, Banjo, Supply, DBW 2010 (W/ Straight Tube)
66	WPX-661-001	Pipe, Fuel, Banjo, Return, DBW 2010 (W/ Straight Tube)
67	WPX-277-282	Screw, Mounting, Fuel Pump
68	WPX-152-544	Washer, Lock, Fuel Pump
69	WPX-886-41A	Nozzle, Fuel, 0.35 GPH
70	WPX-412-198	Manifold, Fuel Nozzle, Brass
71	WPX-277-150	Screw, Plate, Nozzle Stand
72	WPX-102-861	Plate, Manifold
73	WPX-371-289	Gear, Fuel Pump, Nylon
74	WPX-152-390	Snap, Ring, Gear
75	FLX-421-010	Fitting, Hex Union 1.4 in. Tube

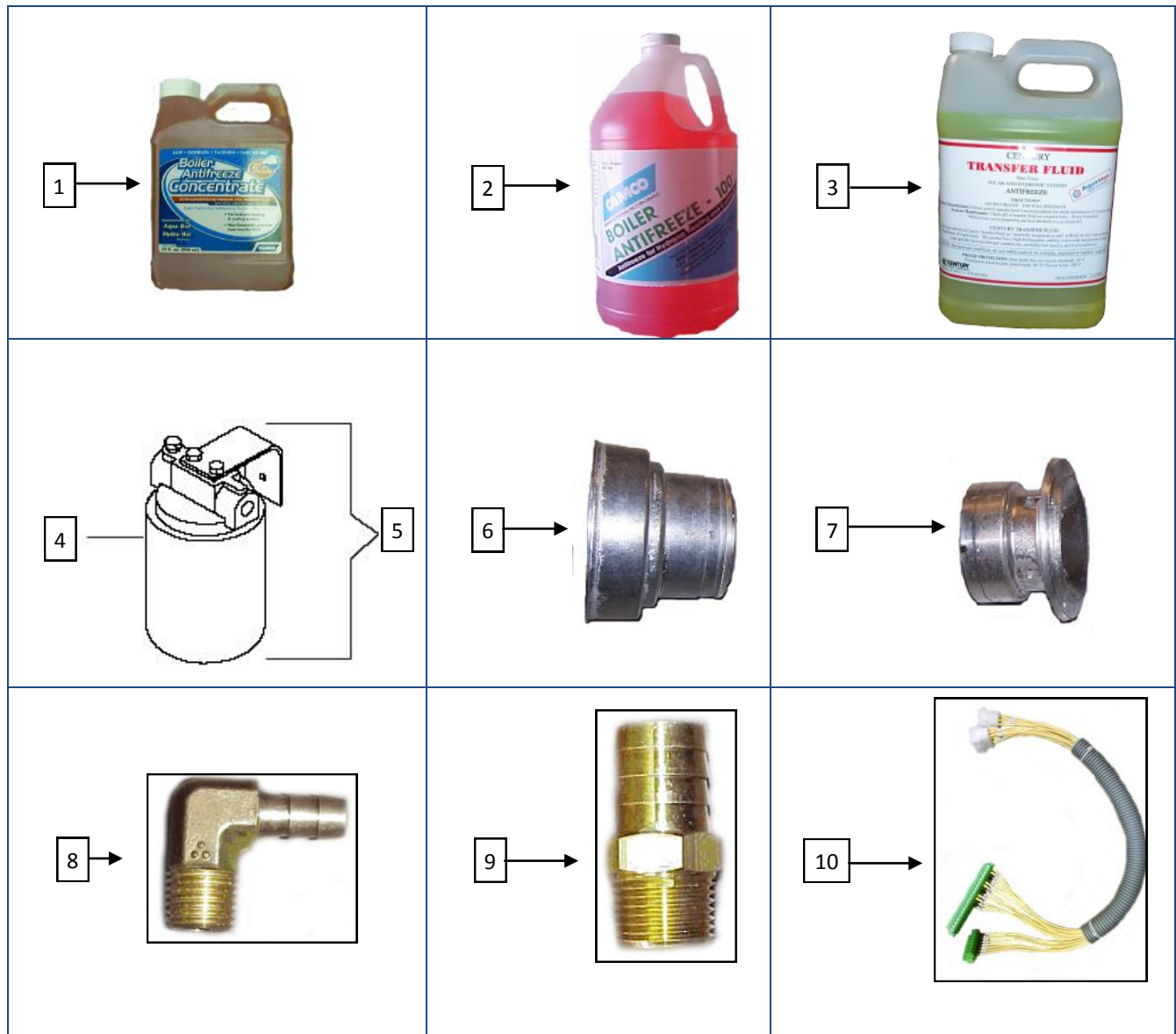

Key	Part Number	Description
1	MSX-300-275	Antifreeze, Boiler, P.G., 1 QT. Concentrate (Camco)
2	MSX-300-270	Antifreeze, Boiler, P.G., 1 Gallon (Camco)
3	MSX-300-300	Antifreeze, Boiler, P.G., 1 Gallon (Century Transfer Fluid)
4	FLE-120-100	Filter, Canister, Replacement, Garber
5	FLX-120-000	Filter, Fuel, Garber
6	WPX-302-828	Housing, Swirler, DBW 2010
7	WPX-302-651	Air Swirler, DBW 2010
MISC. PARTS FOR AHE-450-DW3		
8	FLX-139-5B0	Fitting, Brass, Elbow 90°, Barb 5/16 in. x 1/4 in. (M) NPT
9	PLX-A65-200	Fitting, Brass, Barb, 3/4in. X 1/2 in. (M) NPT
10	ELE-450-001	Harness, Wiring, Winnebago

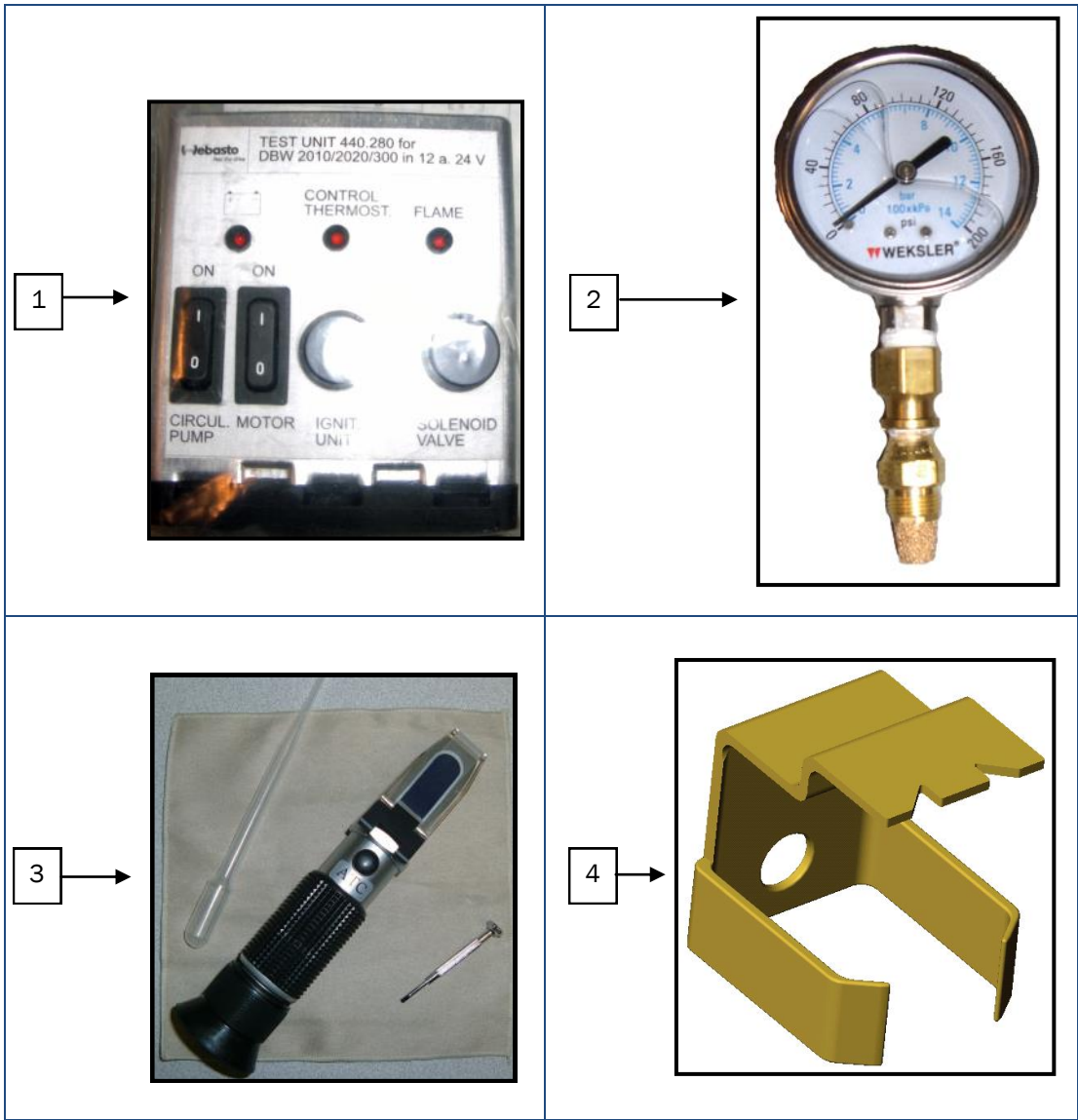

Key	Part Number	Description
1	WPX-440-280	Test, Controller
2	WPE-600-190	Gauge, Fuel Pressure
3	MSX-907-162	Tester, Refractometer, Battery/Coolant
4	WPX-310-646	Gauge, Adjustment, Electrode

PARTS MANUAL

450_{SERIES}



AHE-450-DE4

AHE-450-DW3



7501 Miller Drive, Frederick, CO 80504

Visit us online at www.aquahot.com
Call us at 1(800) 685-4298 or (303) 651-5500

©2014 Aqua-Hot Heating Systems Inc. Printed In U.S.A.